

# 8013 (07005)

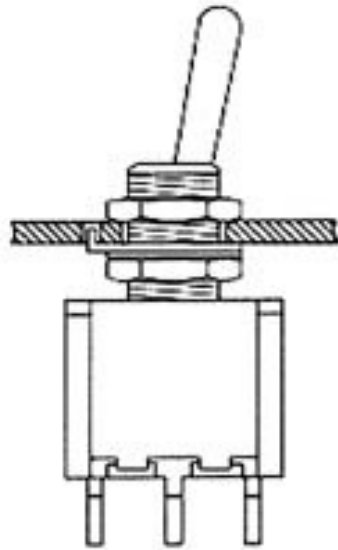

metric bushing

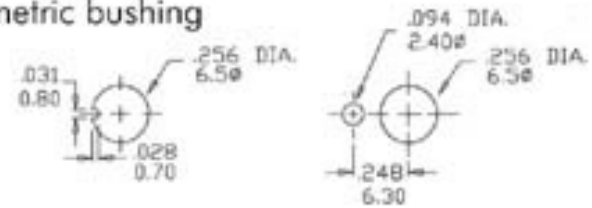

actuator

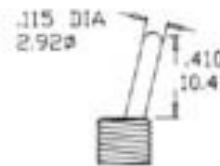

termination options

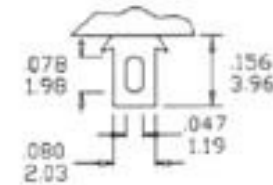

THK .030 (0.76)

STD

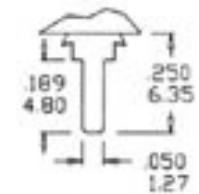

THK .030 (0.76)

printed circuit

dimensions in mm

