

MICRO SWITCH ESS SERIES

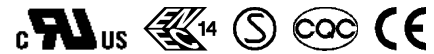

FEATURES

- Small compact size suitable for electric equipment appliances and P.C.B. layout
- 2-piece spring mechanism design offering durable acute operation and long life
- Heavy/Light operation force specifications
- Three Kinds of terminal available soldering, printing and quick connect type
- RoHS Compliant





APPLICATIONS

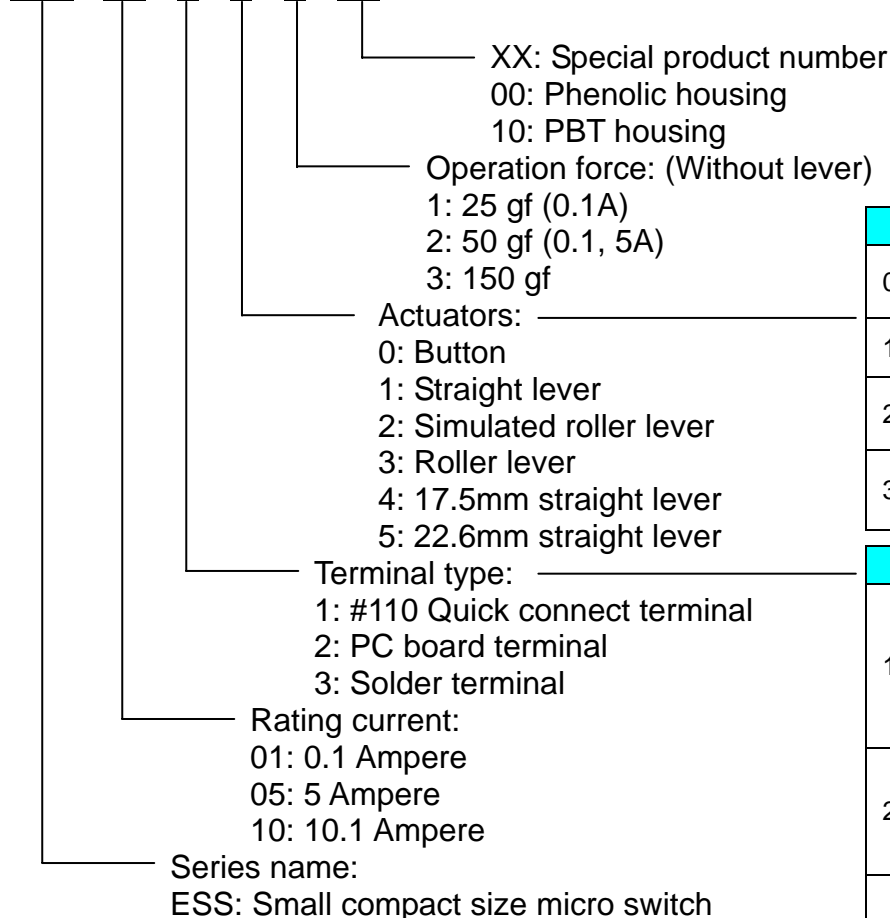

- Communication equipment
- Medical equipment
- A car use
- Vending machines
- Office automation appliances
- Security systems
- Home electric appliances

PART NUMBERING SYSTEM

ESS - XX X X X XX

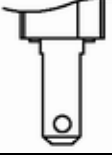

Actuators		
0	Button (without lever)	
1	Straight lever	
2	Simulated roller lever	
3	Roller lever	

Terminal type		
1	#110 Quick connect terminal	
2	PC board terminal	
3	Solder terminal	

■ SPECIFICATIONS

1. ELECTRICAL

DESCRIPTION		TYPE	ESS-01	ESS-05	ESS-10
Contact Rating:	AC 125V		0.1A	5A	----
	AC 250V		----	3A	10.1A
	DC 30V		0.1A	----	----
Contact Resistance: (Initial)	O.F.1.47N (150gf)		50mΩ Max.	30mΩ Max.	30mΩ Max.
	O.F.0.49N (50gf)		100mΩ Max.	50mΩ Max.	----
	O.F.0.25N (25gf)		150mΩ Max.	----	----
Insulation Resistance			100 MΩ Min. at 500 VDC		

2. CHARACTERISTICS

DESCRIPTION		TYPE	ESS-01	ESS-05	ESS-10
Mechanical Life (Cycles Operations)			30,000,000	30,000,000	10,000,000
Electrical Life (Cycles Operations)			200,000	200,000	50,000
Ambient Temperature			-25°C to +85°C (without dew condensation)		
Ambient Humidity			Max. 85% RH		
Max. operating cycle rate	Mechanical		400 cycle/min.		
	Electrical		60 cycle/min.		
Allowable Operation speed			0.1 to 1,000 mm/sec (without lever)		
Dielectric Strength	Between non-continuous terminal		AC 600Vrms	AC 1000Vrms	AC 1000Vrms
	Between each terminal and other exposed metal parts		AC 1500Vrms		
	Between each terminal and ground		AC 1500Vrms		
Vibration Resistance (Without lever)			10 to 55 Hz amplitude of 1.5mm		
Shock Resistance (Without lever)	O.F.1.47N (150gf)		300m/s ² {30G}Min.		
	O.F.0.25N (25gf)		200m/s ² {20G}Min.		
	O.F.0.49N (50gf)		200m/s ² {20G}Min.		
Unit weight			Approx 1.6g		

■ SELECTION GUIDE

	Actuator	O.F. Max. gf	#110 Quick connect terminal	PC board terminal	Solder terminal
0.1A	BUTTON	25gf (0.25N)	ESS01101	ESS01201	ESS01301
		50gf (0.49N)	ESS01102	ESS01202	ESS01302
		150gf (1.47N)	ESS01103	ESS01203	ESS01303
	Straight lever	8gf (0.08N)	ESS01111	ESS01211	ESS01311
		16gf (0.16N)	ESS01112	ESS01212	ESS01312
		50gf (0.49N)	ESS01113	ESS01213	ESS01313
	Simulated roller lever	8gf (0.08N)	ESS01121	ESS01221	ESS01321
		16gf (0.16N)	ESS01122	ESS01222	ESS01322
		50gf (0.49N)	ESS01123	ESS01223	ESS01323
	Roller lever	8gf (0.08N)	ESS01131	ESS01231	ESS01331
		16gf (0.16N)	ESS01132	ESS01232	ESS01332
		50gf (0.49N)	ESS01133	ESS01233	ESS01333
5A	BUTTON	50gf (0.49N)	ESS05102	ESS05202	ESS05302
		150gf (1.47N)	ESS05103	ESS05203	ESS05303
	Straight lever	16gf (0.16N)	ESS05112	ESS05212	ESS05312
		50gf (0.49N)	ESS05113	ESS05213	ESS05313
	Simulated roller lever	16gf (0.16N)	ESS05122	ESS05222	ESS05322
		50gf (0.49N)	ESS05123	ESS05223	ESS05323
	Roller lever	16gf (0.16N)	ESS05132	ESS05232	ESS05332
		50gf (0.49N)	ESS05133	ESS05233	ESS05333
10.1A	BUTTON	150gf (1.47N)	ESS10103	ESS10203	ESS10303
	Straight lever	50gf (0.49N)	ESS10113	ESS10213	ESS10313
	Simulated roller lever	50gf (0.49N)	ESS10123	ESS10223	ESS10323
	Roller lever	50gf (0.49N)	ESS10133	ESS10233	ESS10333



CIRCUIT DIMENSIONS

CIRCUIT DIAGRAM

Unit:mm(inch)

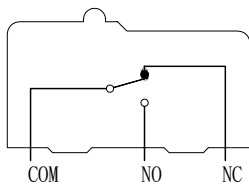

FIX HOLE LAYOUT

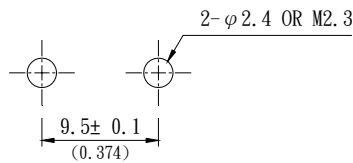

PC board pattern

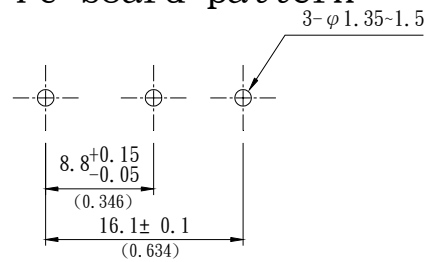

DIMENSIONS

ESS-05 DIMENSIONS Unit:mm(inch)

P/N. : ESS05103
#110 Quick connect terminal

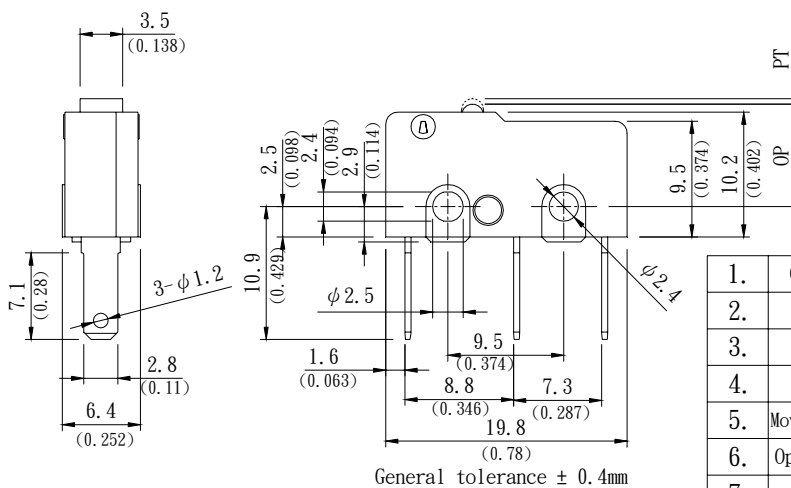

1.	Operating Force (OF)	150gf (1.47N) Max.
2.	Release Force (RF)	25gf (0.25N) Min.
3.	Pre-travel (PT)	0.5mm Max.
4.	Overtravel (OT)	0.5mm Min.
5.	Movement Differential (MD)	0.1mm Max.
6.	Operating Position (OP)	8.4 ± 0.5mm
7.	Free Position (FP)	

ESS-05 DIMENSIONS Unit:mm(inch)

P/N. : ESS05113
#110 Quick connect terminal
Straight lever

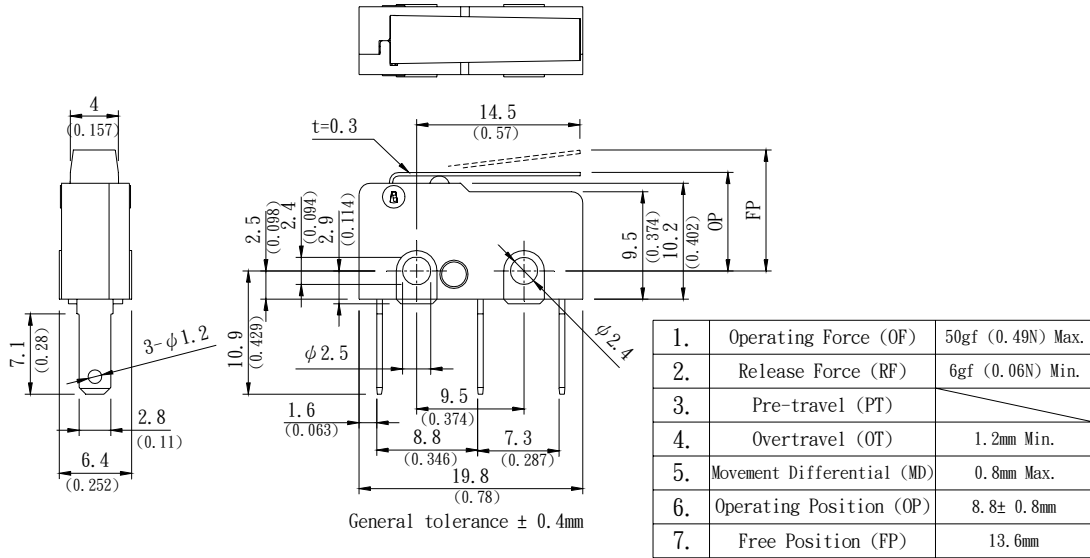

ESS-05 DIMENSIONS Unit:mm(inch)

P/N. : ESS05123
#110 Quick connect terminal
Simulated roller lever

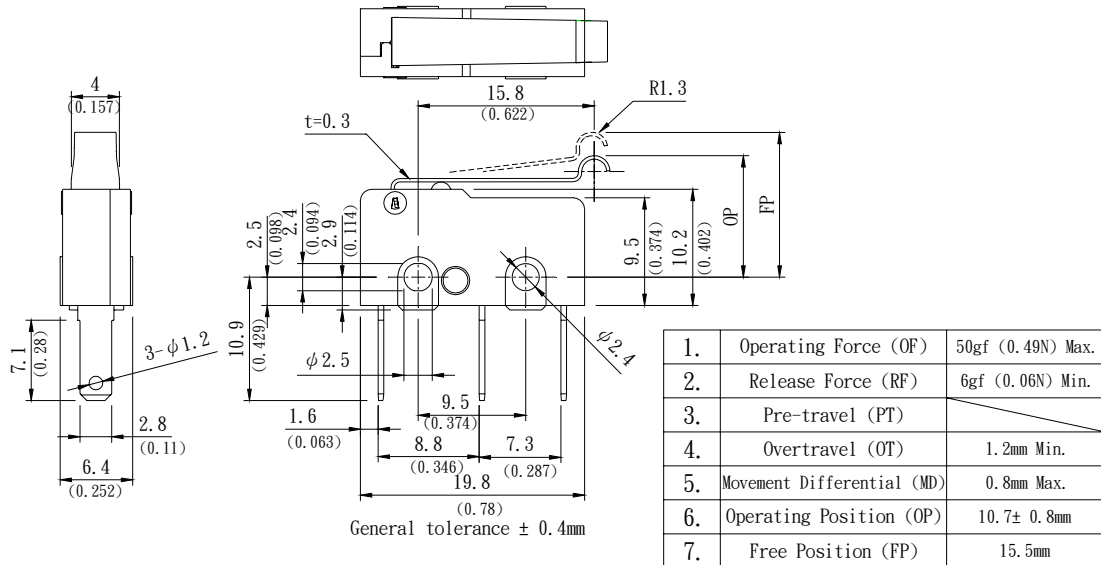

ESS-05 DIMENSIONS Unit:mm(inch)

P/N. : ESS05133

#110 Quick connect terminal

Roller lever

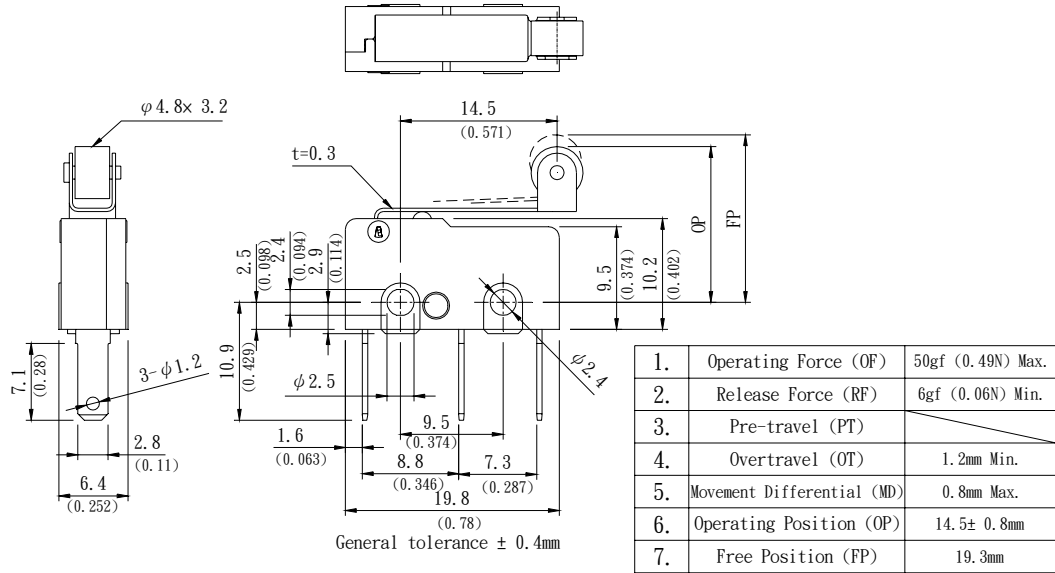

ESS-05 DIMENSIONS Unit:mm(inch)

P/N. : ESS05203

PC board terminal

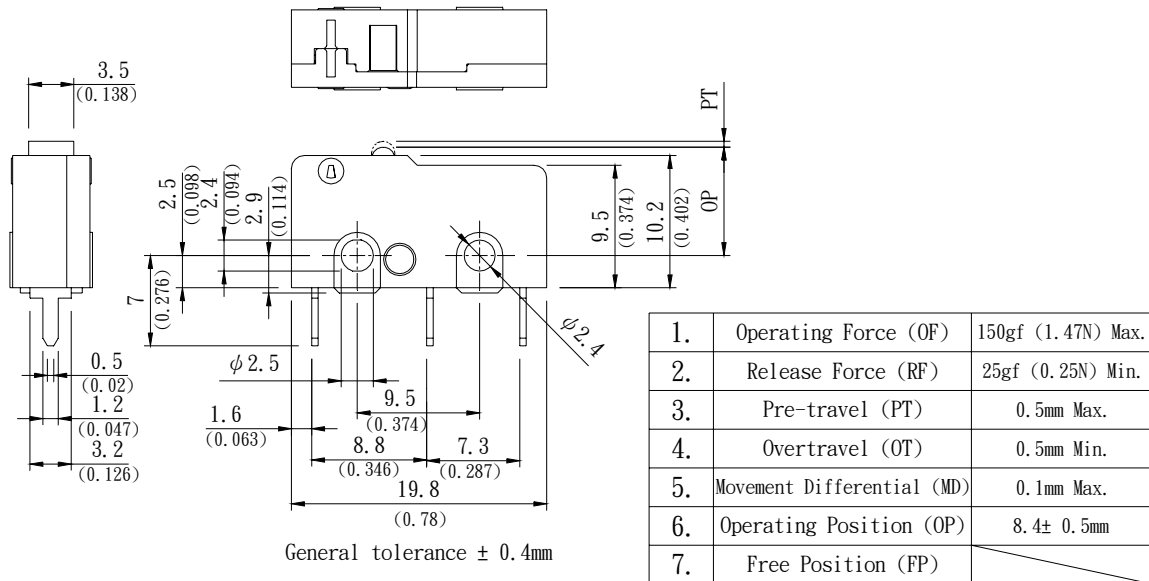

ESS-05 DIMENSIONS Unit:mm(inch)

P/N. : ESS05213
PC board terminal
Straight lever

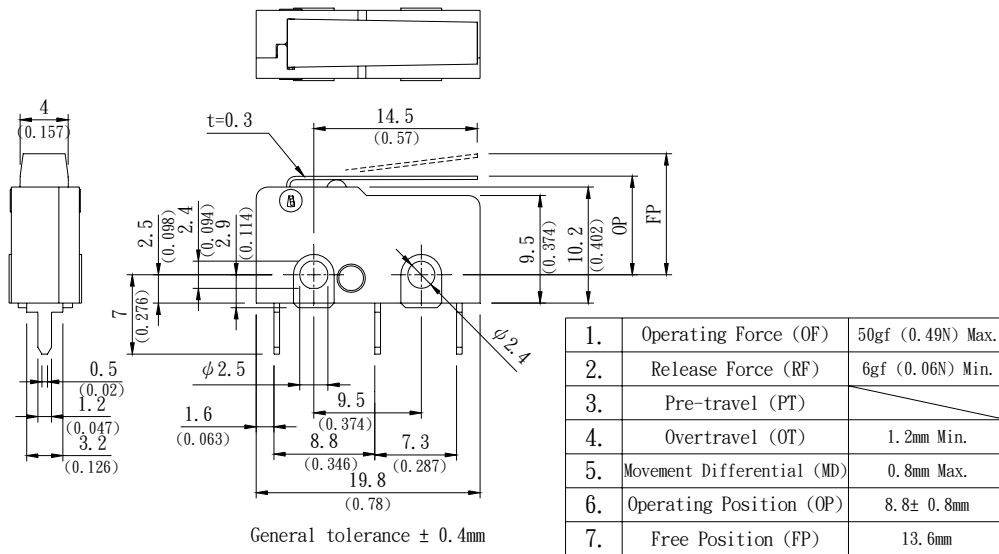

ESS-05 DIMENSIONS Unit:mm(inch)

P/N. : ESS05223
PC board terminal
Simulated roller lever

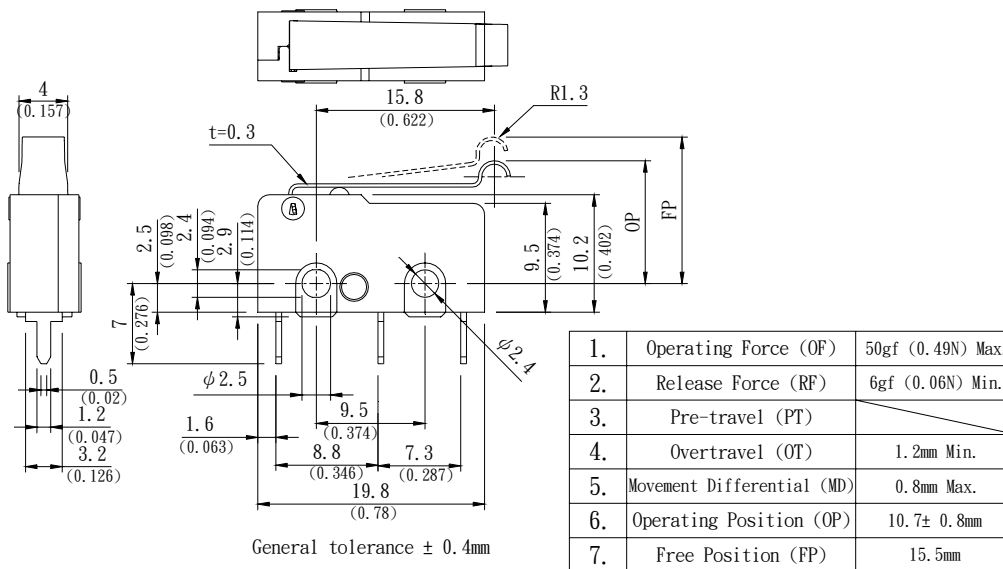

ESS-05 DIMENSIONS Unit:mm(inch)

P/N. : ESS05233
PC board terminal
Roller lever

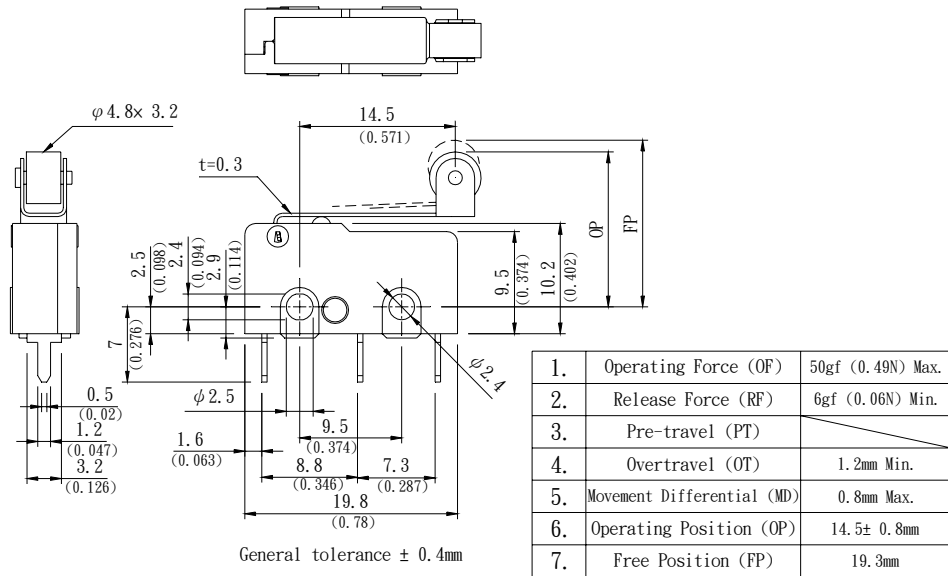

ESS-05 DIMENSIONS Unit:mm(inch)

P/N. : ESS05303
Soldering terminal

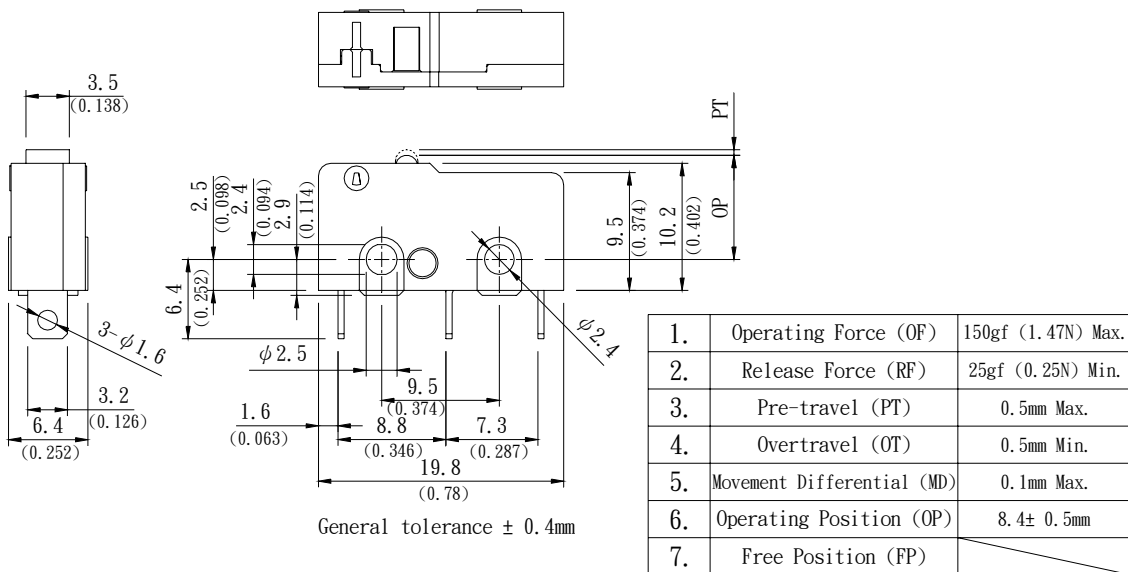

ESS-05 DIMENSIONS Unit:mm(inch)

P/N. ESS05313
Soldering terminal
Straight lever

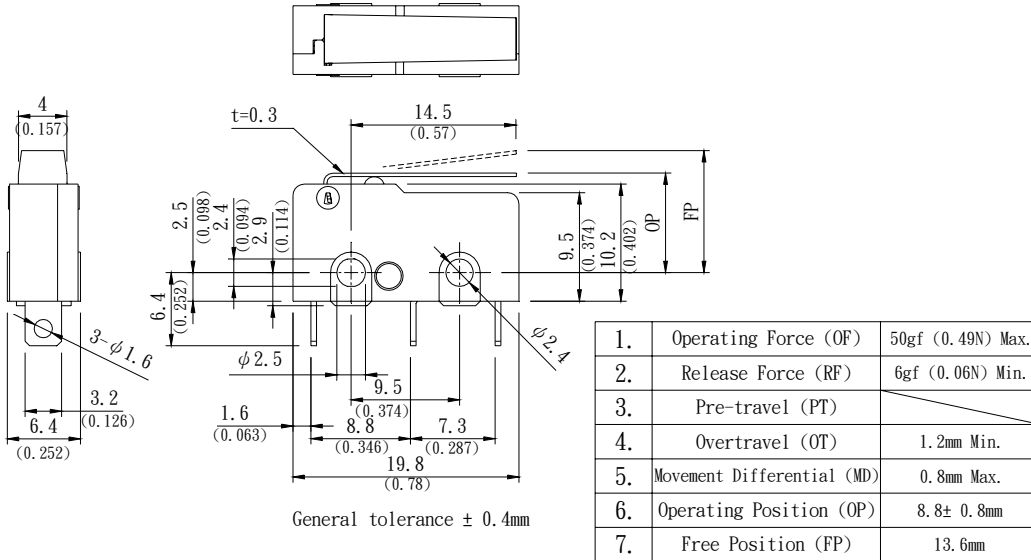

ESS-05 DIMENSIONS Unit:mm(inch)

P/N. : ESS05323
Soldering terminal
Simulated roller lever

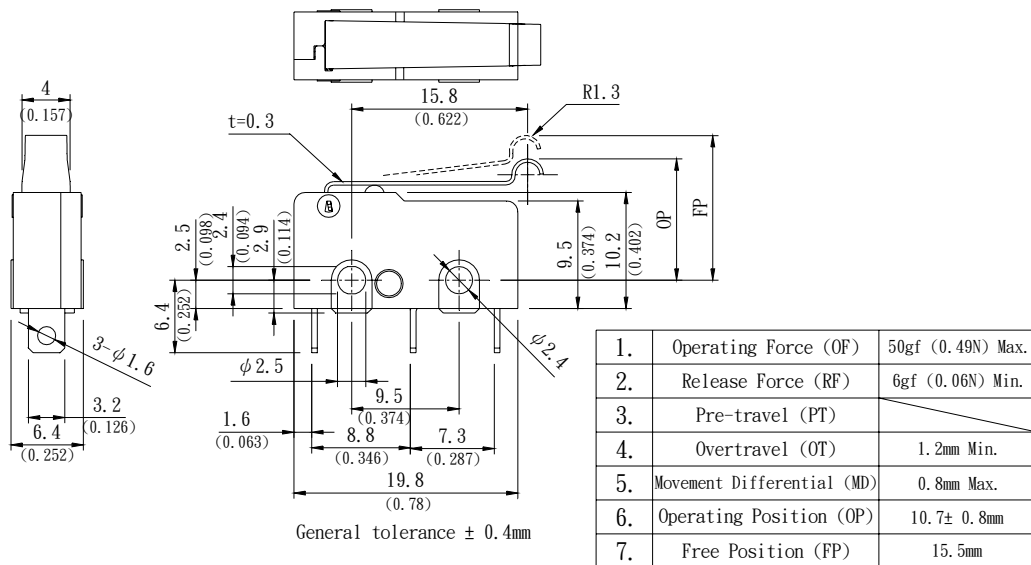

ESS-05 DIMENSIONS Unit:mm(inch)

P/N.: ESS05333
Soldering terminal
Roller lever

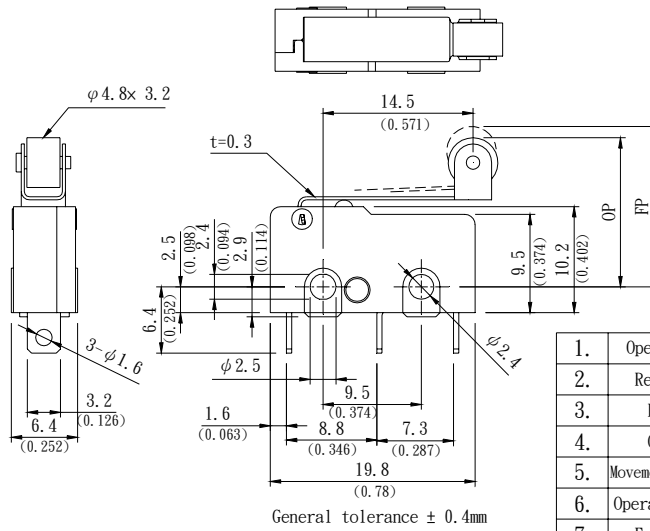

1.	Operating Force (OF)	50gf (0.49N) Max.
2.	Release Force (RF)	6gf (0.06N) Min.
3.	Pre-travel (PT)	
4.	Overtravel (OT)	1.2mm Min.
5.	Movement Differential (MD)	0.8mm Max.
6.	Operating Position (OP)	14.5 \pm 0.8mm
7.	Free Position (FP)	19.3mm