

Resistor - Weerstand - Résistance - Widerstand - Resistencia - Motstand - Vastus - Resistenze

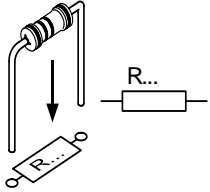

◇R1: 4K7	(Yellow, Purple, Red) -(Geel, Paars, Rood) -(Jaune, Violet, Rouge) -(Gelb, Violet, Rot) -(Gul, Lila, Röd) -(Keltainen, Purppura, Punainen) - (Amarillo, Morado, Rojo) -(Amarelo, Violeta, Lila)
◇R2: 4M7	(Yellow, Purple, Green) -(Geel, Paars, Groen) -(Jaune, Violet, Vert) -(Gelb, Violet, Grün) -(Gul, Lila, Grön) -(Keltainen, Purppura, Vihreä) - (Amarillo, Morado, Verde) -(Amarelo, Violeta, Verde)
◇R3: 68K	(Blue, Grey, Orange) -(Blauw, Grijs, Oranje) -(Bleu, Gris, Orange) -(Blau, Grau, Orange) -(Blå, Grå, Orange) -(Sininen, Harmaa, Oranssi) -(Azul, Gris, Naranja) -(Azul, Cinzento, Castanho)
◇R4, R10, R11, R12, R13, R14: 10K	(Brown, Black, Orange) -(Bruin, Zwart, Oranje) -(Brun, noir, Orange) -(Braun, Schwarz, Orange) -(Brun, Svart, Orange) -(Ruskea, Musta, Oranssi) -(Marrón, Negro, Naranja) -(Castanho, Preto, Laranja) -(Marrone, Nero, Aranciato)
◇R5: 470	(Yellow, Purple, Brown) -(Geel, Paars, Bruin) -(Jaune, Violet, Brun) -(Gelb, Violet, Braun) -(Gul, Lila, Brun) -(Keltainen, Purppura, Ruskea) - (Amarillo, Morado, Marrón) -(Amarelo, Castanho, Marrón)
◇R6: 390	(Orange, White, Brown) -(Oranje, Wit, Bruin) -(Orange, Blanc, Brun) -(Orange, Weiss, Braun) -(Orange, Vit, Brun) -(Oranssi, Valkoinen, Ruskea) -(Naranja, Blanco, Marrón) -(Laranja, Branco, Castanho) -(Aranciato, Bianco, Marrone)
◇R7: 270	(Red, Purple, Brown) -(Rood, Paars, Bruin) -(Rouge, Violet, Brun) -(Rot, Violet, Braun) -(Röd, Lila, Brun) -(Punainen, Purppura, Ruskea) -(Rojo, Morado, Marrón) -(Encarnado, Castanho, Marrón)
◇R8: 150	(Brown, Green, Brown) -(Bruin, Groen, Bruin) -(Brun, Vert, Brun) -(Braun, Grün, Braun) -(Brun, Grön, Brun) -(Ruskea, Vihreä, Ruskea) -(Marrón, Verde, Marrón) -(Castanho, Verde, Marrone)
◇R9: 10	(Brown, Black, Black) -(Bruin, zwart, zwart) -(Brun, Noir, Noir) -(Braun, Schwarz, Schwarz) -(Brun, Svart, Svart) -(Ruskea, Musta, Musta) -(Marrón, Negro, Negro) -(Castanho, Preto, Marrone)

2 DIODE ◇D1... D4: BAT85 Watch the polarity! Att. la polarité!

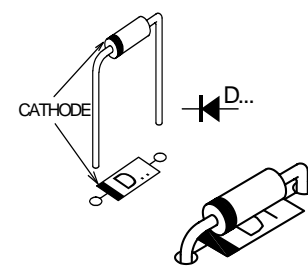

3 ◇LD1... LD5: 3mm Watch the polarity! Att. la polarité!

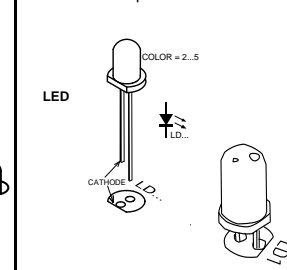

4 -Trimpotentiometer -Potentiomètre de réglage -Potenciómetro de regulación -Trimmerpotentiometri -Trimmerpotentiometer -Trimmer potenziometri

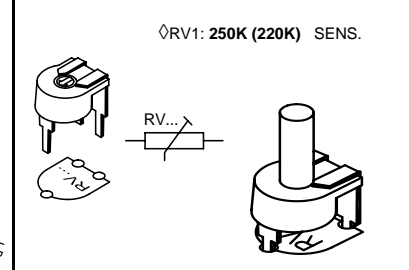

5 Transistor ◇T1... T7: BC547

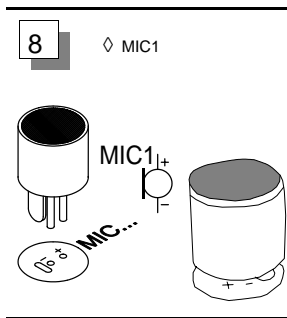

6 ◇E1 (CR2032)

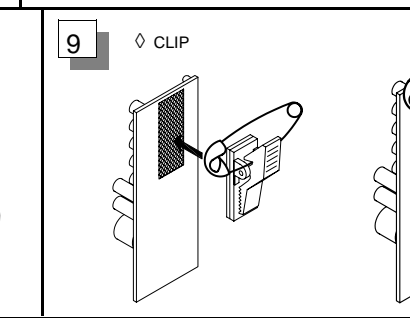

7 ELCO ◇C1: 1µF ◇C2... C4: 10µF Watch the polarity! Att. la polarité!

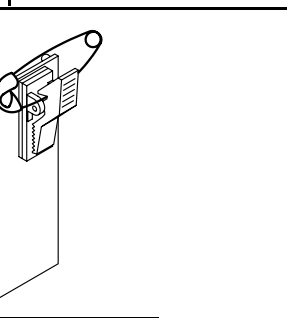

8 ◇MIC1

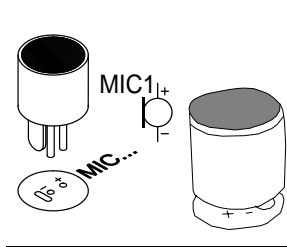

9 ◇CLIP

