



Read this document carefully before using this device. The guarantee will be expired by device damages if you don't attend to the directions in the user manual. Also we don't accept any compensations for personal injury, material damage or capital disadvantages.

## ENDA ET4420 PID TEMPERATURE CONTROLLER

Thank you for choosing ENDA ET4420 PID temperature controller.

- \* 48 x 48mm sized.
- \* Selectable dual setpoint.
- \* Selectable thermocouple types.
- \* Automatic calculation of PID parameters. (SELFTUNE).
- ⚠ **Selftune for automatic PID calculation or manually enter PID parameters if known.**
- \* Three different specifications can be assigned to digital input.
- \* Three different specifications can be assigned to F function key.
- \* Soft-Start feature.
- \* Selectable SSR control output.
- \* C/A2 Relay output programmable as secondary alarm or control output.
- \* A1 Relay output programmable as primary alarm or PID cooling output.
- \* Selectable heating/cooling control.
- \* Zero point input shift.
- \* In the case of sensor failure, manually, periodical or auto-periodical control can be selected.
- \* RS485 ModBus protocol communication feature.(optional)
- \* CE marked according to European Norms.



### TECHNICAL SPECIFICATIONS

Input Type	Temperature Range		Accuracy
	°C	°F	
PT100 Resistance thermometer EN 60751	-199.9...600.0 °C	-199.9...999.9 °F	± 0,2% (of full scale) ± 1 hane
PT100 Resistance thermometer EN 60751	-200...600 °C	-328...1112 °F	± 0,2% (of full scale) ± 1 hane
J (Fe-CuNi) Thermocouple EN 60584	-30.0...600.0°C	-22.0...999.9 °F	± 0,5% (of full scale) ± 1 hane
J (Fe-CuNi) Thermocouple EN 60584	-30...600°C	-22...1112 °F	± 0,5% (of full scale) ± 1 hane
K (NiCr-Ni) Thermocouple EN 60584	-30.0...999.9°C	-22.0...999.9 °F	± 0,5% (of full scale) ± 1 hane
K (NiCr-Ni) Thermocouple EN 60584	-30...1300°C	-22...2372 °F	± 0,5% (of full scale) ± 1 hane
L (Fe-CuNi) Thermocouple DIN 43710	-30.0...600.0°C	-22.0...999.9 °F	± 0,5% (of full scale) ± 1 hane
L (Fe-CuNi) Thermocouple DIN 43710	-30...600°C	-22...1112 °F	± 0,5% (of full scale) ± 1 hane
T (Cu-CuNi) Thermocouple EN 60584	-30.0...400.0°C	-22.0...752.0 °F	± 0,5% (of full scale) ± 1 hane
T (Cu-CuNi) Thermocouple EN 60584	-30...400°C	-22...752 °F	± 0,5% (of full scale) ± 1 hane
S (Pt10Rh-Pt) Thermocouple EN 60584	-40...1700°C	-40...3092 °F	± 0,5% (of full scale) ± 1 hane
R (Pt13Rh-Pt) Thermocouple EN 60584	-40...1700°C	-40...3092 °F	± 0,5% (of full scale) ± 1 hane

### ENVIRONMENTAL CONDITIONS

Ambient/storage temperature	0 ... +50°C/-25... +70°C (with no icing)
Max. Relative humidity	Relative humidity 80% for temperatures up to 31°C decreasing linearly to 50% relative humidity at 40°C.
Rated pollution degree	According to EN 60529 Front panel : Ip65, Rear panel : Ip20
Height	Max. 2000m



Do not use the device in locations subject to corrosive and flammable gases.

### ELECTRICAL CHARACTERISTICS

Supply	110V AC +%10 -%20, 230V AC +%10 -%20, 50/60Hz or 24V AC %10, ± 50/60Hz
Power consumption	Max. 5VA
Wiring	Power connector: 2.5mm <sup>2</sup> screw-terminal, Signal connector: 1,5mm <sup>2</sup> screw-terminal connection.
Line resistance	Max. 100ohm
Data retention	EEPROM (minimum 10 years)
EMC	EN 61326-1: 2012
Safety requirements	EN 61010-1: 2010 (Pollution degree 2, overvoltage category II)

### OUTPUTS

C/A2 output	Relay : 250V AC, 2A (for resistive load), Selectable as NO+NC Control or Alarm2 output.
A1 output	Relay : 250V AC, 2A (for resistive load), NO (Selectable as Alarm1 and Cooling Control output).
SSR output	Max 20mA 24Volt
Life expectancy for relay	Mechanical 30.000.000; Electrical 100.000 operation. 250V AC, 2A (resistive load).

### CONTROL

Control type	Single set-point and alarm control
Control algorithm	On-Off / P, PI, PD, PID (selectable)
A/D converter	12 bit
Sampling time	100ms
Proportional band	Adjustable between 0% and 100%. If Pb=0.0%, On-Off control is selected.
Control period	Adjustable between 1 and 125 seconds
Hysteresis	Adjustable between 1 and 50°C/F
Output power	The ratio of power at a set point can be adjusted between 0% and 100%

### HOUSING

Housing type	Suitable for flush-panel mounting according to DIN 43 700.
Dimensions	W48xH48xD87mm
Weight	Approx. 250g (after packing)
Enclosure material	Self extinguishing plastics.



While cleaning the device, solvents (thinner, benzene, acid etc.) or corrosive materials must not be used.



SISEL MÜHENDİSLİK ELEKTRONİK SAN. VE TİC. A.Ş.  
Şerifali Mah. Barbaros Cad. No:18 Y.Dudullu 34775  
ÜMRANİYE/İSTANBUL-TURKEY  
Tel : +90 216 489 46 64 Pbx. Fax : +90 216 365 74 01  
url : www.enda.com.tr



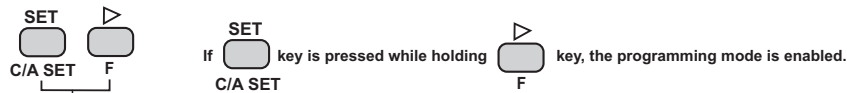

Entering from the programming mode to the run mode:  
If no key is pressed within 20 seconds during programming mode, the data is stored automatically and the run mode is entered.

Alternatively, the same function occurs first pressing **F** key is pressing programming mode is entered. Then **SET** **F** keys are pressing together, data is recorded and running mode is entered.

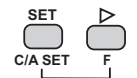

<b>Con.o</b>	<b>AL 1.o</b>	<b>AL 2.o</b>	<b>CONF.</b>	<b>Stun.</b>	<b>SECU.</b>
<b>CSLo</b> 0	<b>R15L</b> 0	<b>R25L</b> 0	<b>inPt</b> J	<b>Stu5</b> 25	<b>SECo</b> 0
<b>CSHh</b> 600	<b>R15H</b> 600	<b>R25H</b> 600	<b>UnIt</b> oC	<b>Pdt</b> 25	<b>SECo</b> 0
<b>CPb</b> 40	<b>R1HY</b> 2	<b>R2HY</b> 2	<b>FLtr</b> 5		
<b>CHY5</b> 2	<b>R1tP</b> inDE	<b>R2tP</b> inDE	<b>Co5E</b> C-R2		
<b>CEi</b> 40	<b>R15t</b> h1	<b>R25t</b> h1	<b>oFF5</b> 0		
<b>CEd</b> 100	<b>R1Er</b> on	<b>R2Er</b> on	<b>dAdr</b> 1		
<b>CEt</b> 1	<b>R1Pb</b> 0	<b>R2Pb</b> 0	<b>bRud</b> 960		
<b>CP5t</b> 0	<b>R1tI</b> 0	<b>R2tI</b> 0	<b>d.inL</b> nonE		
<b>CEct</b> EP5	<b>R1tD</b> 0	<b>R2tD</b> 0	<b>FFEL</b> oFF		
<b>CEP5</b> 0	<b>R1tE</b> 1	<b>R2tE</b> 1			
<b>55t5</b> 0	<b>R1P5</b> 0	<b>R2P5</b> 0			
<b>CEYP</b> HEAt	<b>R1EP</b> 0	<b>R2EP</b> 0			

**CSLo** = CIA1 Output Control setpoint value lower limit. Adjustable between 0 and **CSHh**.

**CSHh** = CIA1 Output Control setpoint value upper limit. Adjustable between **CSLo** and Upper

**CPb** = CIA1 Output Proportional band value. Adjustable between %0.0 and %100.0. If **CPb**=%0.0, On-Off control is selected.

**CHY5** = CIA1 Output Hysteresis output value. Adjustable between 1 and 50°C. **!** If **CPb**=0, this parameter is active.

**CEi** = CIA1 Output Integral value. Adjustable between 0.0 and 100.0 minutes. **CEi** = 0.0, integral impact is disable. **!** If **CPb** parameter is different from "0", this parameter appears.

**CEd** = CIA1 Output Derivative value. Adjustable between 0.0 and 25.00 minutes. **CEd** = 0.0, derivative time is disabled. **!** If **CPb** parameter is different from "0", this parameter appears.

**CEt** = CIA1 Output Period time. Adjustable between 1 and 250 second. **!** **CPb** parameter is different is different from "0", this parameter appears.

**CP5t** = At CIA1 Set value, CIA1 percent of power. Adjustable between 0% and 100%.

**CEct** = Faulty sensor control type. If **CEct**=**EP5**, in the case of probe failure according to **CEP5** proportional value of the parameter control is performed. If **CEct**=**Aut**, in the case of probe failure, the fault found and recorded before the last setpoint control with the control percentage is performed.

**CEP5** = In the case of probe failure, CIA1 output percentage adjustable between %0 and %100. **!** If **CEct**=**EP5** or **CPb**=00 is selected, this parameter is activated. In the case of failure, if **CPb**=00 (ON/Off Control) and **CEP5**=0 output will be Off, if different from "0" value, output will be ON.

**55t5** = Soft Start timer set value. This parameter indicates the time to reach set point value when the device is first energised. Adjustable between 0 and 250 minutes. If 0 is selected, soft start feature will be enable and the device reaches set point value quickly. **!** Setting **Pb** = 0, soft start feature will be disabled.

**CEYP** = Control output type  
**CEYP** = **HEAt** means heating control.  
**CEYP** = **COOL** means cooling control.

**R15L** = Alarm1 set value lower limit. Adjustable between 0 and **R15H** parameter value.

**R15H** = Alarm1 set value upper limit. Adjustable between **R15L** parameter value and upper scale value.

**R1HY** = Hysteresis of the Alarm1 output. Adjustable between 1 and 50°C.

**R1tP** = Type of Alarm1. Six kinds of functions can be selected. **inDE**= Independent alarm  
**dE** = Deviation alarm  
**bRnD** = Band alarm (Band)  
**bRnI** = Band with inhibition  
**inCo** = A1 output independent cooling control  
**rELCo** = A1 output relative cooling control

**R15t** = Alarm1 output situation. If Alarm1 output **H**=A1 output is above the Alarm1 set value; on.  
**Lo**=A1 output is above the Alarm1 set value; off.  
**!** **R1tP** parameter, **inCo** or **rELCo** is selected; this parameter is not seen.

**R1Er** = Alarm1 probe failure situation. **on**= A1 output probe failure; on.  
**oFF**= A1 output probe failure; off.  
**!** **R1tP** parameter, **inCo** or **rELCo** is selected, this parameter is not seen.

**R1Pb** = A1 output, value of proportional band. Adjustable between 0% and 100%. **R1Pb**= 0%, On-Off control is selected. **!** **R1tP** parameter, **inCo** or **rELCo** is selected, this parameter is activated.

**R1tI** = A1 output integral value. Adjustable between 0.0 and 100.0 minute. **R1tI** = 0.0 effect of integral disable. **!** **R1tP** parameter, **inCo** or **rELCo** is selected and if **R1Pb** different from "0", this parameter is activated.

**R1tD** = A1 output derivative value. Adjustable between 0.0 and 25.00 minute. **R1tD** = 0.00 effect of derivative disable. **!** **R1tP** parameter **inCo** or **rELCo** is selected and if **R1Pb** different from "0", this parameter is activated.

**R1tE** = A1 output period time. Adjustable between 1 and 250sec. **!** **R1tP** parameter **inCo** or **rELCo** is selected and if **R1Pb** different from "0", this parameter is activated.

**R1P5** = At A1 Set value, A1 output percent of power. Adjustable between 0% and 100%. **!** **R1tP** parameter **inCo** or **rELCo** is selected and if **R1Pb** different from "0", this parameter is activated.

**R1EP** = At A1 Set value, A1 output percent of power. Adjustable between 0%-100%. **!** **R1tP** parameter **inCo** or **rELCo** is selected, this parameter is activated.

**!** For SSR output devices, if **Co5E** parameter is different from **C-R2**, this menu is visible.

**R25L** = Alarm2 set value lower limit. Adjustable between 0 and **R25H** parameter value.

**R25H** = Alarm2 set value upper limit. Adjustable between **R25L** parameter value and upper scale value.

**R2HY** = Hysteresis of the Alarm2 output. Adjustable between 1 and 50°C.

**R2tP** = Type of Alarm2. Four kinds of functions can be selected. **inDE**= Independent alarm  
**dE** = Deviation alarm  
**bRnD** = Band alarm  
**bRnI** = Band with inhibition

**R25t** = Alarm2 output situation. **H**= A2 output is above the set value; on.  
**Lo**= A2 output is above the set value; off.

**R2Er** = Alarm2 probe failure situation. **on**= A2 output probe failure; on.  
**oFF**= A2 output probe failure; off.

**inPt** = Type of input selection.  
**PE0** = PT100 decimal,  
**PE** = PT100 Non-decimal,  
**J0** = J Type decimal,  
**J** = J Type Non-decimal,  
**K0** = K Type decimal,  
**K** = K Type Non-decimal,  
**L0** = L Type decimal,  
**L** = L Type Non-decimal,  
**T0** = T Type decimal,  
**T** = T Type,  
**S** = S Type,  
**r** = R Type, thermocouple selection.  
**!** This parameter varies when changing some parameters.

**UnIt** = The temperature unit.  
**oC**=°C, **oF**=°F  
**!** This parameter varies when changing some parameters.

**FLtr** = Coefficient of digital filter. Adjustable between 1 and 200. If this parameter is 1, digital filter runs most quick. If the parameter is 35, the filter run most slow. The value of parameter should be increased in interference.

**Co5E** = Control output selection  
**C-R2** = CIA2 (Relay) output selection  
**55f** = SSR output selection

**oFF5** = Offset value. Offset value is added to the measuring value. This feature which is the point of measurement due to its distance measurement probe, is used to eliminate errors that might occur. Adjustable between -99 and 99°C, for decimal values can be adjusted between -10.0 and 10°C. Normal value=0.

**dAdr** = Device address for RS485 connection. Adjustable between 1 and 247. **!** This parameter is active devices with RS485 communications option.

**bRud** = ModBus baud rate for RS485 connection. Selectable as; off, 2.4, 4.8, 9.6, 19.20 ve 38.40. **!** This parameter is active devices with RS485 communications option.

**d.inL** = Digital input setting parameter. **nonE**= Digital input is closed.  
**CE5A**= If digital input is activated, 2nd set value is used.  
**nRnu** = Manual mode start in case of digital outputs are active and rational output generated according to period value in **CEt** parameter and percentage value in **55tE** parameter.  
**d5Pa** = If the digital input is activated; temperature indicator mode can be exceed.

**FFEL** = Function key setting parameter. **nonE** = Function key is closed.  
**CE5A** = The function key is used with the 2nd set value.  
**nRnu** = Manual mode can be exceed by using the function key.  
**d5Pa** = Temperature indicator mode can be exceed by using function key.

**Stu5** = Self tune control parameter. If **SET** **F** keys are pressed together, the device returns to the main screen and if the temperature is not high, **Pdt** message flashes on display and self tune process starts automatically. If the initial temperature is higher to self-tune, **tEt** message appears and the device waits until the temperature goes down. Then **Pdt** message appears and automatically self tune procedure is starts. After the self tune procedure, **CPb**, **CEt**, **CEd** and **CEt** values are recorded in the memory. Then the device returns to Run Mode. After the successful self tune completion, **Stun.** menu is removed automatically. In order to re-tune, **St5c** parameter should be set to **PYE5** in **SECU** menu.

**SECo** = Security menu access code. It should be 442. **!** If in **SECo**=0 position, first held down **SET** key then pressed **F** key for 4 seconds **dEFF** message is displayed and return to the factory settings.

**Co5c** = Parameter of **Con.o** menu security level.  
**nonE** = Menu invisible.  
**PYE5** = Modification can be done.  
**Pno** = Only visible.

**R15c** = Parameter of **AL 1.o** menu security level.  
**nonE** = Menu invisible.  
**PYE5** = Modification can be done.  
**Pno** = Only visible.

**R25c** = Parameter of **AL 2.o** menu security level.  
**nonE** = Menu invisible.  
**PYE5** = Modification can be done.  
**Pno** = Only visible.

**CE5c** = Parameter of **CONF.** menu security level.  
**nonE** = Menu invisible.  
**PYE5** = Modification can be done.  
**Pno** = Only visible.

**St5c** = Parameter of **Stun.** menu security level.  
**nonE** = Invisible.  
**PYE5** = Modification can be done.

**STOPPING SELF TUNE**

If self tune process wanted to be terminated for any reason, programming mode entered and **Stun.** menu opened with **SET** **F** and **SET** **F** keys, **Stu5** parameter selected with **SET** **F** keys, **Stu5** parameter selected with **SET** **F** keys pressed together in order to stop self tune process and turn to main display.

**Parametre ayarlama diyagramı**

When holding **SET** key, the value of parameter flashes and using **F** keys the requested value can be adjusted.

If **SET** key is pressed and held 0.6 seconds, the value of the selected parameter changes rapidly. If waited enough, the value increases 100 at each step. After 1 second following the release of the key, initial condition is returned. The same procedure is valid for the decrement key.

# TERMS

(1) Measuring value and set value indicators (In Run Mode)  
Parameter name and value (In Programming Mode)

(2) Value increment key (in Run and Programming Mode)  
Parameter selection key (in Programming Mode)

(3) Value decrement key (in Run and Programming Mode)  
If only this key is pressed in operating mode, the program version number is displayed.  
Parameter selection key (in Programming Mode)

(4) Selectable function key (in Run Mode)  
Menu selection key (in Programming Mode)

(5) Control and alarm set selection key (in Run Mode)  
Parameter set key (in Programming Mode)

(7) State indicator

(1) PV and SV display	PV 7 Segment 4 Digits Red, SV 7 Segment 4 Digits Yellow LED display
Character Heights	PV and SV indicator : 7.2 mm
(2),(3),(4),(5) Keypad	Micro switch
(7) State indicator	For Control, Alarm1 and SSR outputs 3 digits red LED

## ALARM1 AND ALARM2 OUTPUT TYPES

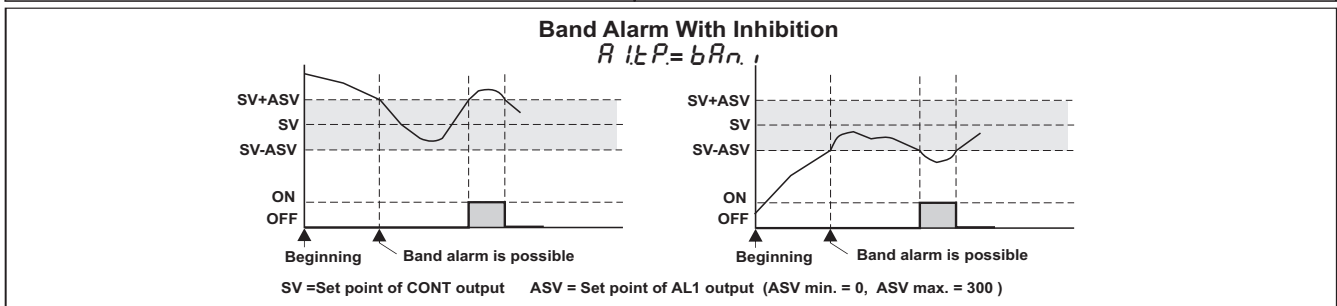
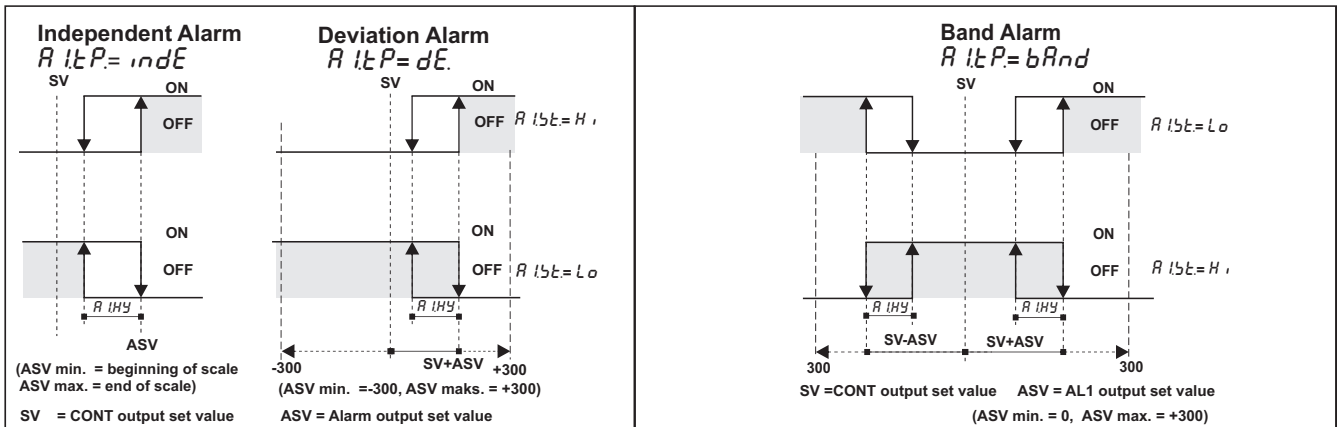

## MODIFICATION OF CONTROL AND ALARM SET POINTS

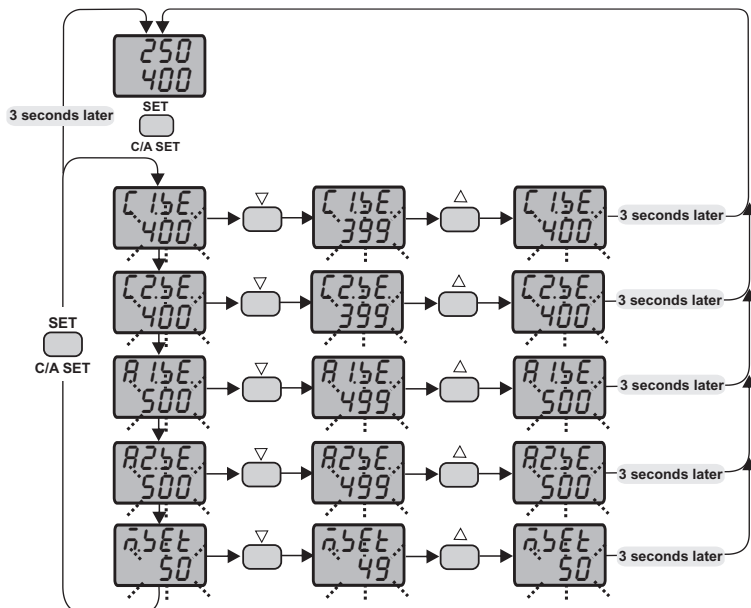

**ERROR MESSAGES**

**PFA** 400 Temperature sensor is broken.

**400** Temperature value is higher than the scale.

**-400** Temperature value is broken or over temperature.

If one of the  $d\ i\ n\ c.$  or  $F\ t\ E\ c.$  parameters are set to the  $C\ 2\ 5\ E$  value, this parameter is seen.

If the  $C\ o\ b\ E$  parameter is set to SSR out, this parameter is seen.

If one of the  $d\ i\ n\ c.$  or  $F\ t\ E\ c.$  parameters are set to the  $\bar{n}\ A\ n\ u$  value and if  $C\ P\ b$  is different from 0, this parameter is seen.

## DIMENSIONS:

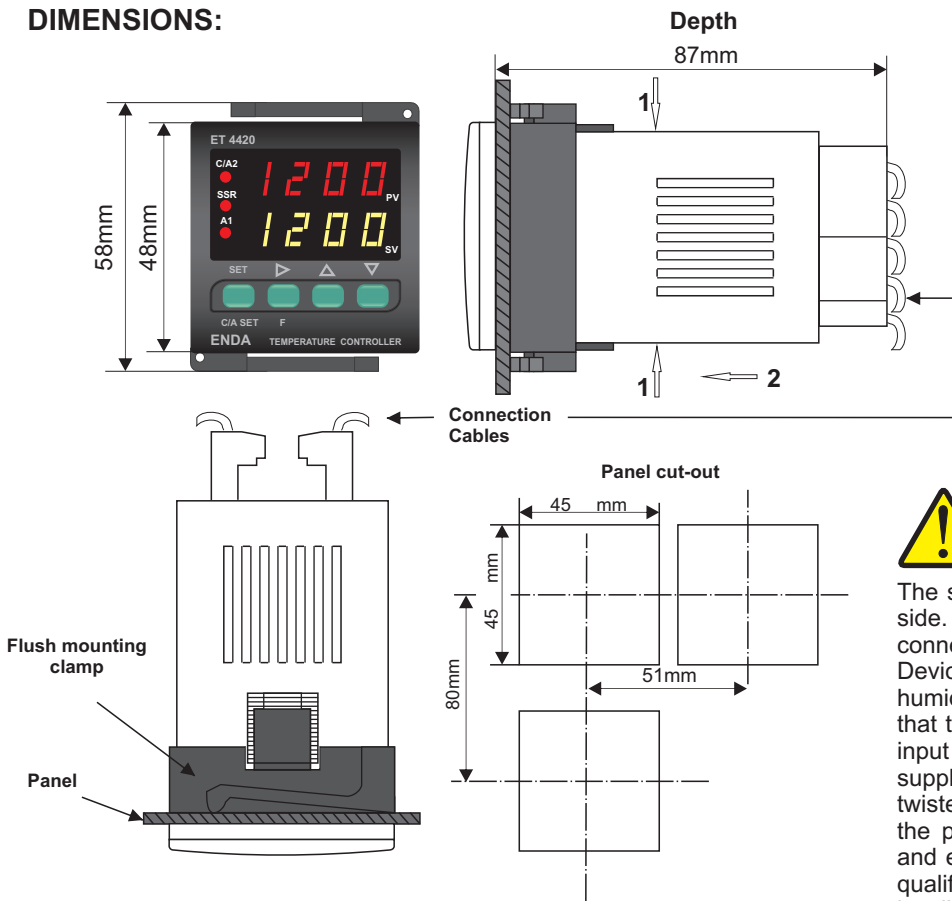

**For removing the device from the panel:**  
 - While pressing both side of the device in direction 1, push it in direction 2.

**Note :**

- 1) While panel mounting, additional distance required for connection cables should be considered.
- 2) Panel thickness should be maximum 9mm.
- 3) If there is no 100mm free space at back side of the device, it would be difficult to remove it from the panel.



**ENDA ET4420** is intended for installation in control panels. Make sure that the device is used only for intended purpose.

The shielding must be grounded on the instrument side. During an installation all of the cables that are connected to the device must be free of energy. Device must be protected against inadmissible humidity, vibrations, severe soiling and make sure that the operation temperature is not exceeded. All input and output lines that are not connected to the supply network must be laid out as shielded and twisted cables. These cables should not be close to the power cables or components. The installation and electrical connections must be carried on by a qualified staff and must be according to the relevant locally applicable regulations.

## CONNECTION DIAGRAM

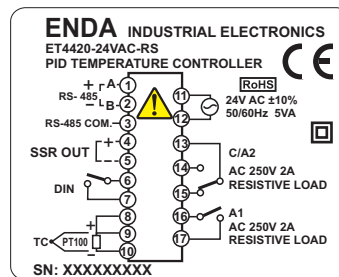
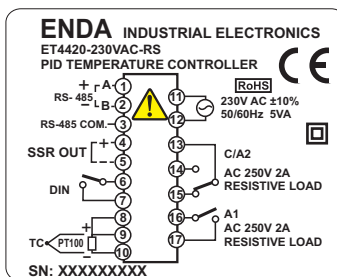
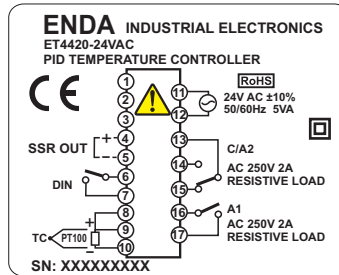
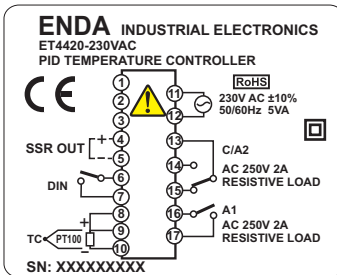

Logic output of the instrument is not electrically insulated from the internal circuits. Therefore, when using a grounding thermocouple, do not connect the logic output terminals to the ground.

- Note :**
- 1) Mains supply cords shall meet the requirements of IEC 60227 or IEC 60245.
  - 2) In accordance with the safety regulations, the power supply switch shall bring the identification of the relevant instrument and it should be easily accessible by the operator.

Holding screw  
0.4-0.5Nm

Equipment is protected throughout by DOUBLE INSULATION.

Order Code : ET4420 -      -

- 1- Supply Voltage**  
 110VAC...110V AC  
 230VAC...230V AC  
 24VAC...24V AC

- 2- Modbus Option**  
 RS.....RS-485 Modbus Communication  
 None...RS-485 Modbus Communication not supported.

**NOTE :**  
**SUPPLY VOLTAGE**

184-253V AC OR  
 21.6-26.4V AC  
 50/60Hz 5VA



Fuse should be connected.  
 F 100 mA 250V AC

**SENSOR INPUT:**

**For Thermocouple :**  
 Use the correct compensating cable. Do not make any supplement to cables. Connect the thermocouple cables to the right places at the input terminal.

**For PT100 Sensor :**  
 When using 2-wire PT100, short circuit the 8 and 9 input terminals.

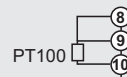
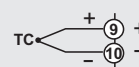

# ENDA ET4420 PID TEMPERATURE CONTROLLER MODBUS ADDRESS MAP

## 1.1 Memory Map for Holding Registers

Parameter Number	Holding Register Addresses Desimal (Hex)	Data Type	Data Content	Read / Write Permission	Factory Defaults	
<b>Control Output Parameters</b>	<b>H0</b>	0000d (0000h)	Word	Control output, temperature setpoint value	Read / Write	400
	<b>H1</b>	0001d (0001h)	Word	Control output, 2nd temperature setpoint value	Read / Write	400
	<b>H2</b>	0002d (0002h)	Word	Control output, minimum setpoint value	Read / Write	0
	<b>H3</b>	0003d (0003h)	Word	Control output, maximum setpoint value	Read / Write	600
	<b>H4</b>	0004d (0004h)	Word	Control output, proportional band setpoint value (Adjustable between %0.0 and %100.0)	Read / Write	4
	<b>H5</b>	0005d (0005h)	Word	Control output, hysteresis value (Adjustable between 1 and 50 °C or °F)	Read / Write	2
	<b>H6</b>	0006d (0006h)	Word	Control output, integral time (Adjustable between 0.1 and 100.0 minute)	Read / Write	40
	<b>H7</b>	0007d (0007h)	Word	Control output, derivative time (Adjustable between 0.01 and 10.00 minute)	Read / Write	100
	<b>H8</b>	0008d (0008h)	Word	Control output, time period setpoint value (Adjustable between 1 and 125 second)	Read / Write	20
	<b>H9</b>	0009d (0009h)	Word	Control output, set value power ratio (Adjustable between %0 and %100)	Read / Write	0
	<b>H10</b>	0010d (000Ah)	Word	Control output, set value power ratio in case of sensor failure (Adjustable between %0 and %100)	Read / Write	0
<b>H11</b>	0011d (000Bh)	Word	Control output, soft start value	Read / Write	0	
<b>A1 Output Parameters</b>	<b>H12</b>	0012d (000Ch)	Word	Alarm1 output temperature setpoint value	Read / Write	500
	<b>H13</b>	0013d (000Dh)	Word	Alarm1 output minimum setpoint value limit	Read / Write	0
	<b>H14</b>	0014d (000Eh)	Word	Alarm1 output maximum setpoint value limit	Read / Write	600
	<b>H15</b>	0015d (000Fh)	Word	Alarm1 output proportional band set value (Adjustable between %0.0 and %100.0)	Read / Write	0
	<b>H16</b>	0016d (0010h)	Word	Alarm1 output hysteresis value (Adjustable between 1 and 50 °C or °F)	Read / Write	2
	<b>H17</b>	0017d (0011h)	Word	Alarm1 output, integral time (Adjustable between 0.1 and 100.0 minute)	Read / Write	0
	<b>H18</b>	0018d (0012h)	Word	Alarm1 output, derivative time (Adjustable between 0.01 and 10.00 minute)	Read / Write	0
	<b>H19</b>	0019d (0013h)	Word	Alarm1 output, time period setpoint value (Adjustable between 1 and 125 second)	Read / Write	20
	<b>H20</b>	0020d (0014h)	Word	Alarm1 output, set value power ratio (Adjustable between %0 and %100)	Read / Write	0
	<b>H21</b>	0021d (0015h)	Word	Alarm1 output, set value power ratio in case of sensor failure (Adjustable between %0 and %100)	Read / Write	0
	<b>H22</b>	0022d (0016h)	Word	Alarm1 output type selection (Values can be given from 0 to 4) (0 = Independent alarm, 1 = Deviation alarm, 2 = Band alarm, 3 = Active alarm after in band time, 4 = Alarm1 output, cooling control selection )	Read / Write	0
<b>A2 Output Parameters</b>	<b>H23</b>	0023d (0017h)	Word	Alarm2 output, temperature setpoint value	Read / Write	500
	<b>H24</b>	0024d (0018h)	Word	Alarm2 output minimum setpoint value limit	Read / Write	0
	<b>H25</b>	0025d (0019h)	Word	Alarm2 output maximum setpoint value limit	Read / Write	600
	<b>H26</b>	0026d (001Ah)	Word	Alarm2 output, hysteresis value (Adjustable between 1 and 50 °C or °F)	Read / Write	2
	<b>H27</b>	0027d (001Bh)	Word	Alarm2 output type selection (Values can be given from 0 to 3) (0 = Independent alarm, 1 = Deviation alarm, 2 = Band alarm, 3 = Active alarm after in band time)	Read / Write	0
<b>Configuration Parameters</b>	<b>H28</b>	0028d (001Ch)	Word	Input selection number (0 = PT100 Decimal, 1 = Pt100 Non-decimal, 2 = J Decimal, 3 = J Non-decimal, 4 = K Decimal, 5 = K Non-decimal, 6 = L Decimal, 7 = L Non-decimal, 8 = T Decimal, 9 = T Non-decimal, 10= S Non-decimal, 11 = R Non-decimal.	Read / Write	5
	<b>H29</b>	0029d (001Dh)	Word	ModBus device address (Adjustable between 1 and 247)	Read / Write	1
	<b>H30</b>	0030d (001Eh)	Word	Modbus communication speed (Baudrate) (0 = Modbus cancel, 1 = 2400 bps, 2 = 4800 bps, 3 = 9600 bps, 4 =19200 bps, 5 = 38400 bps)	Read / Write	3
	<b>H31</b>	0031d (001Fh)	Word	Digital filter coefficient (Adjustable between 1 and 200, 1 = filter is disable)	Read / Write	10
	<b>H32</b>	0032d (0020h)	Word	Control output, selection value (0 = C/A2 Control output selection, 1 = SSR Output )	Read / Write	0
	<b>H33</b>	0033d (0021h)	Word	Reserved	Read / Write	XX
	<b>H34</b>	0034d (0022h)	Word	Reserved	Read / Write	XX
	<b>H35</b>	0035d (0023h)	Word	Offset value	Read / Write	0
	<b>H36</b>	0036d (0024h)	Word	Function control parameter. ( 23040d ( 5A00h ) self tune stops when this value is entered ) ( 23041d ( 5A01h ) self tune starts when this value is entered ) ( 23042d ( 5A02h ) returns to factory defaults when this value is entered)	Read / Write	0
	<b>H37</b>	0037d (0025h)	Word	Reserved	Read / Write	XX
	<b>H38</b>	0038d (0026h)	Word	Reserved	Read / Write	XX
	<b>H39</b>	0039d (0027h)	Word	Manual control output percentage (Adjustable between %0 and %100)	Read / Write	50

## 1.1 Memory Map for Holding Registers (continue)

Parameter Number	Holding Register Addresses Desimal (Hex)	Data Type	Data Content	Read / Write Permission	Factory Defaults	
<b>Configuration Parameters</b>	<b>H40</b>	0040d (0028h)	Word	Digital input control parameter ( 0 = Digital input off, 1 = 2nd set value is selected with digital input, 2 = Manual mode is entered via digital input, 3 = Digital input is passed to display mode)	Read / Write	0
	<b>H41</b>	0041d (0029h)	Word	Function key control parameter ( 0 = Function key off, 1 = 2nd Set value is selected with function key, 2 = Manual mode is entered via function key, 3 = With the function key display mode is entered)	Read / Write	0
	<b>H42</b>	0042d (002Ah)	Word	Reserved	Read / Write	XX
	<b>H43</b>	0043d (002Bh)	Word	Reserved	Read / Write	XX
	<b>H44</b>	0044d (002Ch)	Word	Reserved	Read / Write	XX
	<b>H45</b>	0045d (002Dh)	Word	Reserved	Read / Write	XX
	<b>H46</b>	0046d (002Eh)	Word	Reserved	Read / Write	XX
	<b>H47</b>	0047d (002Fh)	Word	Reserved	Read / Write	XX
	<b>H48</b>	0048d (0030h)	Word	Control output menu, security parameter ( 0 = Menu invisible, 1 = Menu programmable, 2 = Menu only visible )	Read / Write	1
	<b>H49</b>	0049d (0031h)	Word	Alarm1 output menu security parameter ( 0 = Menu invisible, 1 = Menu programmable, 2 = Menu only visible )	Read / Write	1
	<b>H50</b>	0050d (0032h)	Word	Alarm2 output menu, security parameter ( 0 = Menu invisible, 1 = Menu programmable, 2 = Menu only visible )	Read / Write	1
	<b>H51</b>	0051d (0033h)	Word	Configuration menu, security parameter ( 0 = Menu invisible, 1 = Menu programmable, 2 = Menu only visible )	Read / Write	1
	<b>H52</b>	0052d (0034h)	Word	Self tune menu, security parameter ( 0 = Menu invisible, 1 = Self tune can be done)	Read / Write	1

## 1.2 Memory Map for Coils

Parameter Number	Coil Addresses	Data Type	Data Content	Read / Write Permission	Factory Defaults
<b>C0</b>	(0000)h	Bit	Alarm2 Status (0 = Active Low ,1 =Active High)	Read / Write	1
<b>C1</b>	(0001)h	Bit	Alarm2 output position in case of Prob failure (0 = Off , 1 = On )	Read / Write	0
<b>C2</b>	(0002)h	Bit	Alarm1 Status (0 = Active Low ,1 =Active High)	Read / Write	1
<b>C3</b>	(0003)h	Bit	Alarm1 output position in case of Prob failure (0 = Off , 1 = On )	Read / Write	0
<b>C4</b>	(0004)h	Bit	Control output configuration ( 0 = Heat ; 1 = Cool )	Read / Write	0
<b>C5</b>	(0005)h	Bit	Temperature unit (0 = °C ; 1 = °F)	Read / Write	0
<b>C6</b>	(0006)h	Bit	Control outputs active (0 = Control outputs active, 1 = Only display mode)	Read / Write	0
<b>C7</b>	(0007)h	Bit	Controlling according to 2nd temperature setpoint (If C7 = 0 is H0, if C7 = 1 is H1)	Read / Write	0
<b>C8</b>	(0008)h	Bit	Auto/Manual selection (0 = Automatic Run Mode, 1 = Manual Run Mode. In this mode, output generated according to H39 parameter.)	Read / Write	0
<b>C9</b>	(0009)h	Bit	Control format in case of probe failure (0 = H10 proportional control according to percentage value, 1 = Error found before the setpoint control is done with the value of the proportional control)	Read / Write	0

## 1.3 Memory Map for Input Registers

Parameter Number	Input Register Addresses Desimal (Hex)	Data Type	Data Content	Read / Write Permission
<b>I0</b>	0000d (0000h)	Word	Measured temperature	Read Only
<b>I1</b>	0001d (0001h)	Word	Percentage of analog output	Read Only
<b>I2</b>	0002d (0002h)	Word	Measurement error codes 0 = No error, 1 = Sensor disconnected or broken, 2 = Lower scale error, 3 = Upper scale error, 4 = PT100 short circuit or temperature too low, 5 = Wrong input selection	Read Only
<b>I3</b>	0003d (0003h)	Word	Self tune condition codes 0 = No error, 1 = Initial temperature is higher than 60% setpoint value, 2 = Calculating PID parameters, 3 = Calculating power set parameters	Read Only
<b>I4</b>	0004d (0004h)	Word	Current (active) temperature setpoint.	Read Only
<b>I5</b>	0005d (0005h)	Word	Reserved	Read Only
<b>I6</b>	0006d (0006h)	Word	Current (active) decimal point value (0 = No decimal point, 1 = 0.0 Decimal point is tenths)	Read Only

## 1.4 Memory Map for Software Revision Input Registers

Software Revision	61472d (F020h)	14 Word	Software name and update is read in ASCII format and as 14 word. Sample : ET4420-01 03 Dec 2013. Memory Formats : Word Word Word Word Word Word Word Word Word Word Word Word Word Word Word 1 2 3 4 5 6 7 8 9 10 11 12 13 14 <b>TE 44 02 0 - 1         3 0 D CE 2 1 0 .3</b>	Read Only
			<b>NOTE :</b> To view each word correctly by changing the byte sequences should be displayed as ASCII TEXT	

## 1.5 Memory Map for Discrete input

Parametre Numarası	Discrete Input Addresses	Data Type	Data Content	Read / Write Permission
<b>D0</b>	(0000)h	Bit	C/A2 Control output status (0 = OFF ,1 = ON)	Read Only
<b>D1</b>	(0001)h	Bit	A1 Output status (0 = OFF , 1 = ON )	Read Only
<b>D2</b>	(0002)h	Bit	SSR Output status (0 = OFF ,1 = ON)	Read Only
<b>D3</b>	(0003)h	Bit	Digital input status (0 = OFF ,1 = ON)	Read Only

## 2. MODBUS ERROR MESSAGES

Modbus protocol has two types error, communication error and operating error. Reason of the communication error is data corruption in transmission. Parity and CRC control should be done to prevent communication error. Receiver side checks parity and CRC of the data. If they are wrong, the message will be ignored. If format of the data is true but function doesn't perform for any reason, operating error occurs. Slave realizes error and sends error message. Most significant bit of function is changed '1' to indicate error in error message by slave. Error code is sent in data section. Master realizes error type via this message.

### ModBus Error Codes

Error Code	Name	Meaning
01	ILLEGAL FUNCTION	The function code received in the query is not an allowable action for the slave. If a Poll Program Complete command was issued, this code indicates that no program function preceded it.
02	ILLEGAL DATA ADDRESS	The data address received in the query is not an allowable address for the slave.
03	ILLEGAL DATA VALUE	A value contained in the query data field is not an allowable value for the slave.

Message example;

Structure of command message (Byte Format)

Device Address		(0A)h
Function Code		(01)h
Beginning address of coils.	MSB	(04)h
	LSB	(A1)h
Number of coils (N)	MSB	(00)h
	LSB	(01)h
CRC DATA	LSB	(AC)h
	MSB	(63)h

Structure of response message (Byte Format)

Device Address		(0A)h
Function Code		(81)h
Error Code		(02)h
CRC DATA	LSB	(B0)h
	MSB	(53)h

As you see in command message, coil information of (4A1)h = 1185 is required but there isn't any coil with 1185 address. Therefore error code with number (02) (Illegal Data Address) sends.