

PCB Relay

G5V-1

Ultra-miniature, Highly Sensitive SPDT Relay for Signal Circuits

- Ultra-miniature at 12.5 x 7.5 x 10 mm (L x W x H).
- Wide switching capacity of 1 mA to 1 A.
- High sensitivity: 150 mW nominal coil power.
- Plastic-sealed construction.
- International 2.54-mm terminal pitch.
- Conforms to FCC Part 68 requirements for coil to contacts.

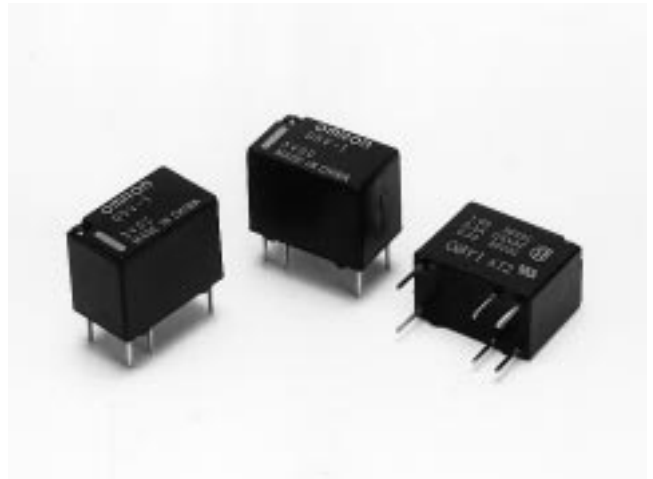

Ordering Information

Classification				Model
Contact form	Contact type	Contact material	Structure	
SPDT	Single crossbar	Ag + Au-clad	Plastic-sealed	G5V-1

Note: When ordering, add the rated coil voltage to the model number.

Example: G5V-1 12 VDC

Rated coil voltage

Model Number Legend:

G5V - VDC
1 2

1. Contact Form
1: SPDT

2. Rated Coil Voltage
3, 5, 6, 9, 12, 24 VDC

Specifications

■ Coil Ratings

Rated voltage		3 VDC	5 VDC	6 VDC	9 VDC	12 VDC	24 VDC
Rated current		50 mA	30 mA	25 mA	16.7 mA	12.5 mA	6.25 mA
Coil resistance		60 Ω	167 Ω	240 Ω	540 Ω	960 Ω	3,840 Ω
Coil inductance (H) (ref. value)	Armature OFF	0.05	0.15	0.20	0.45	0.85	3.48
	Armature ON	0.11	0.29	0.41	0.93	1.63	6.61
Must operate voltage		80% max. of rated voltage					
Must release voltage		10% min. of rated voltage					
Max. voltage		200% of rated voltage at 50°C, 160% at 70°C					
Power consumption		Approx. 150 mW					

Note: 1. The rated current and coil resistance are measured at a coil temperature of 23°C with a tolerance of ±10%.

2. Operating characteristics are measured at a coil temperature of 23°C.

■ Contact Ratings

Load	Resistive load (cosφ = 1)
Rated load	0.5 A at 125 VAC; 1 A at 24 VDC
Contact material	Ag + Au-clad
Rated carry current	2 A
Max. switching voltage	125 VAC, 60 VDC
Max. switching current	1 A
Max. switching capacity	62.5 VA, 30 W
Min. permissible load	1 mA at 5 VDC

Note: P level: $\lambda_{60} = 0.1 \times 10^{-6}/\text{operation}$

■ Characteristics

Contact resistance	100 mΩ max.
Operate time	5 ms max. (mean value: approx. 2.5 ms)
Release time	5 ms max. (mean value: approx. 0.9 ms)
Bounce time	Operate: approx. 0.2 ms Release: approx. 5 ms
Max. operating frequency	Mechanical: 36,000 operations/hr Electrical: 1,800 operations/hr (under rated load)
Insulation resistance	1,000 MΩ min. (at 500 VDC between coil and contacts, at 250 VDC between contacts of same polarity.)
Dielectric strength	1,000 VAC, 50/60 Hz for 1 min between coil and contacts 400 VAC, 50/60 Hz for 1 min between contacts of same polarity
Impulse withstand voltage	1,500 V 10 x 160 μs between coil and contacts (conforms to FCC Part 68)
Vibration resistance	Destruction: 10 to 55 Hz, 3.3-mm double amplitude Malfunction: 10 to 55 Hz, 3.3-mm double amplitude
Shock resistance	Destruction: 1,000 m/s ² (approx. 100G) Malfunction: 100 m/s ² (approx. 10G)
Life expectancy	Mechanical: 5,000,000 operations min. (at 18,000 operations/hr) Electrical: 100,000 operations min. (under rated load, at 1,800 operations/hr)
Ambient temperature	Operating: -40°C to 70°C (with no icing) Storage: -40°C to 70°C (with no icing)
Ambient humidity	Operating: 35% to 85%
Weight	Approx. 2 g

■ Approved Standards

UL478, 1950 (File No. E41515)/CSA C22.2 No.0, No.14 (File No. LR24825)

Model	Contact form	Coil ratings	Contact ratings
G5V-1	SPDT	3 to 24 VDC	0.5 A, 125 VAC (general use) 0.3 A, 60 VDC (resistive load) 1 A, 30 VDC (resistive load)

Engineering Data

Max. Switching Capacity

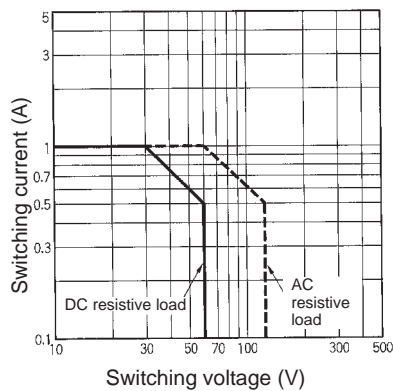

Life Expectancy

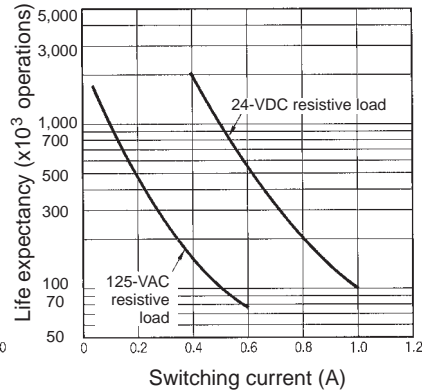

Ambient Temperature vs. Maximum Voltage

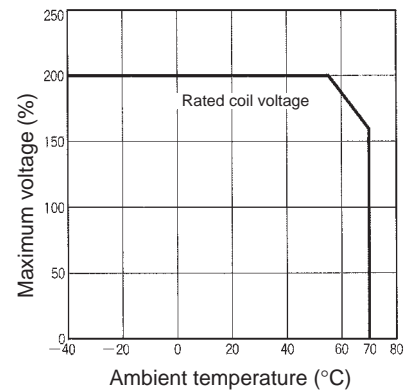

Dimensions

- Note:**
1. All units are in millimeters unless otherwise indicated.
 2. Numbers in parentheses are reference values.
 3. Tolerance: ± 0.1
 4. Orientation marks are indicated as follows:

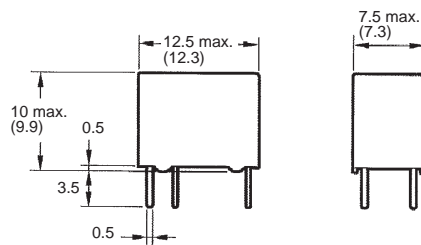
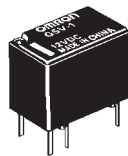

Terminal Arrangement/ Internal Connections (Bottom View)

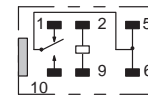

Mounting Holes (Bottom View)

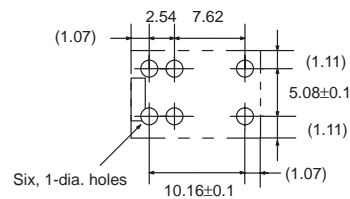

ALL DIMENSIONS SHOWN ARE IN MILLIMETERS.
 To convert millimeters into inches, multiply by 0.03937. To convert grams into ounces, multiply by 0.03527.