

8013C (07025)

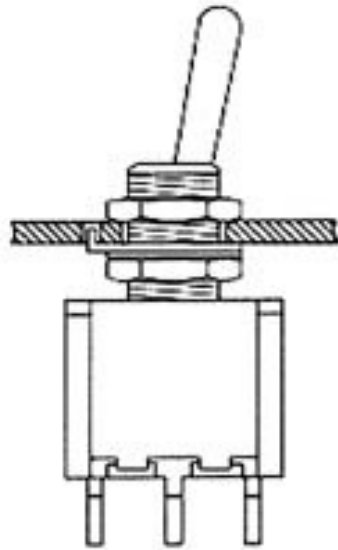

metric bushing

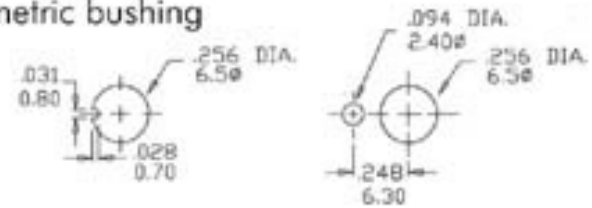

actuator

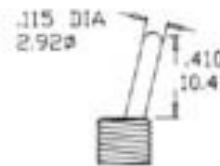

termination options

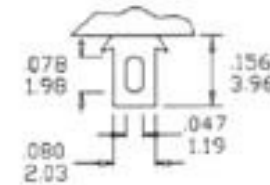

THK .030 (0.76)

STD

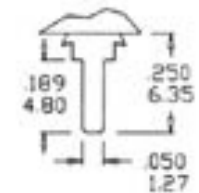

THK .030 (0.76)

printed circuit

dimensions in mm

