



MN1500

Size: AA (LR6)

Alkaline-Manganese Dioxide Battery

Zn/MnO₂

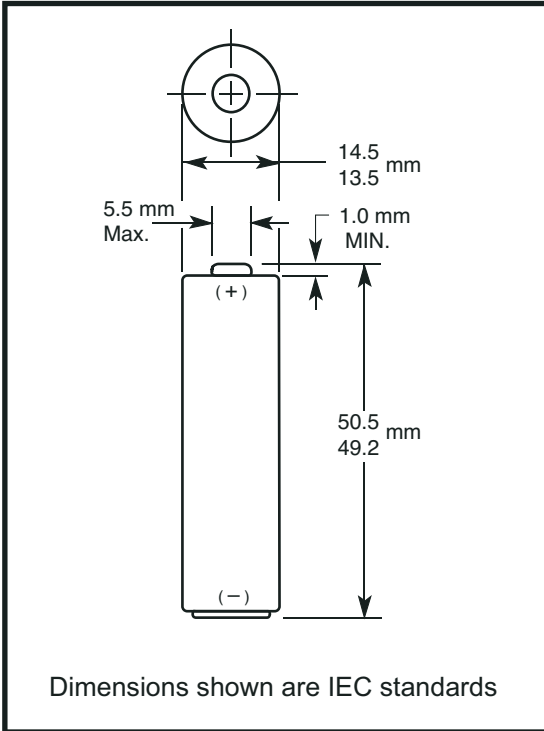

| | |
|-------------------------------------|---|
| Nominal Voltage: | 1.5 V |
| Operating Voltage | 1.6 - 0.75V |
| Impedance: | 120 m-ohm @ 1kHz |
| Typical Weight: | 24 gm (0.8 oz.) |
| Typical Volume: | 8.4 cm ³ (0.5 in. ³) |
| Terminals: | Flat |
| Storage Temperature Range: | -20°C to 35°C |
| Operating Temperature Range: | -20°C to 54°C (-4°F to 130°F) |
| ANSI: | 15A |
| IEC: | LR6 |

TYPICAL DISCHARGE CHARACTERISTICS AT 21°C (70°F)

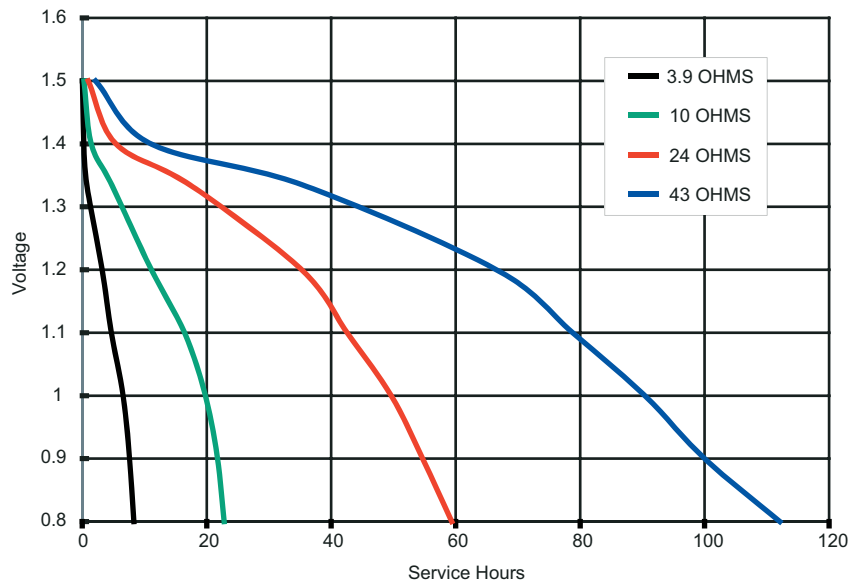

DURACELL[®]
BATTERIES

Berkshire Corporate Park
Bethel, CT 06801 U.S.A.
Telephone: Toll-free 1-800-544-5454
Internet: www.duracell.com

* Delivered capacity is dependent on the applied load, operating temperature and cut-off voltage. Please refer to the charts and discharge data shown for examples of the energy / service life that the battery will provide for various load conditions.



MN1500

Size: AA (LR6)

Alkaline-Manganese Dioxide Battery

Zn/MnO₂

TYPICAL CONSTANT CURRENT DISCHARGE CHARACTERISTICS AT 21°C (70°F)

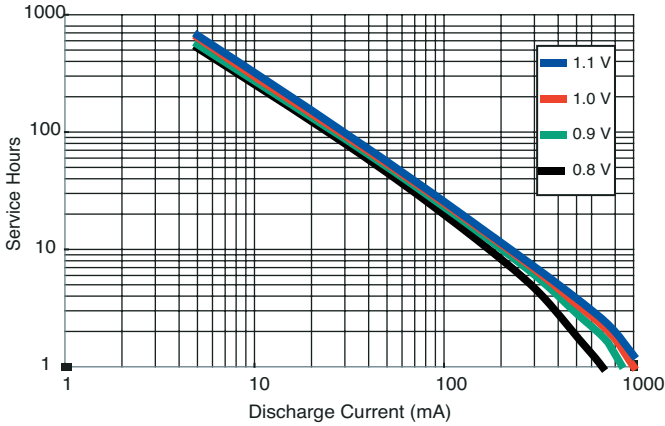

TYPICAL DISCHARGE CHARACTERISTICS AT 21°C (70°F)

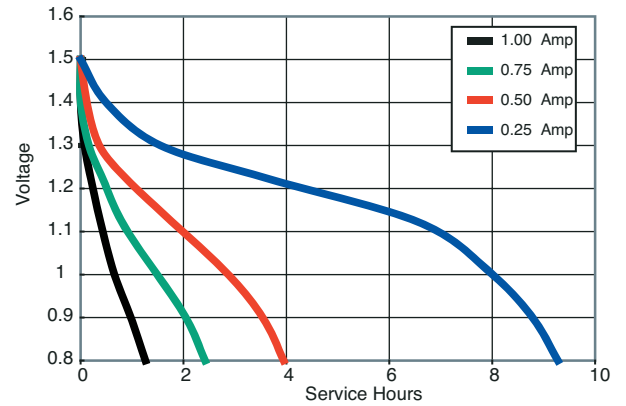

TYPICAL DISCHARGE CHARACTERISTICS AT 21°C (70°F)

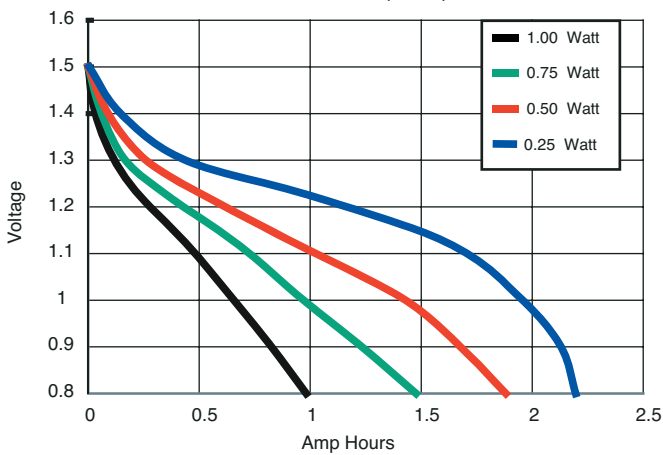

TYPICAL DISCHARGE PERFORMANCE AT 21°C (70°F)

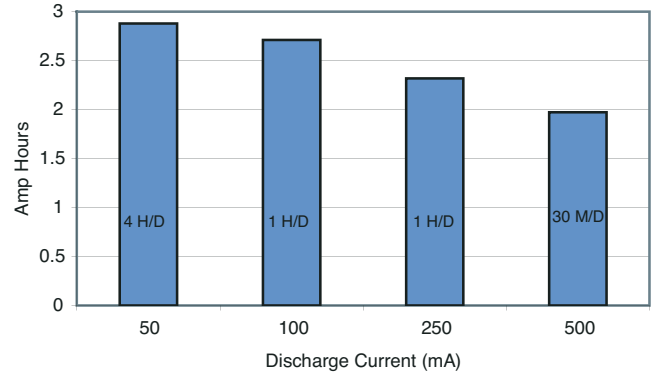

TYPICAL DC RESISTANCE CHARACTERISTICS AT 21°C (70°F)

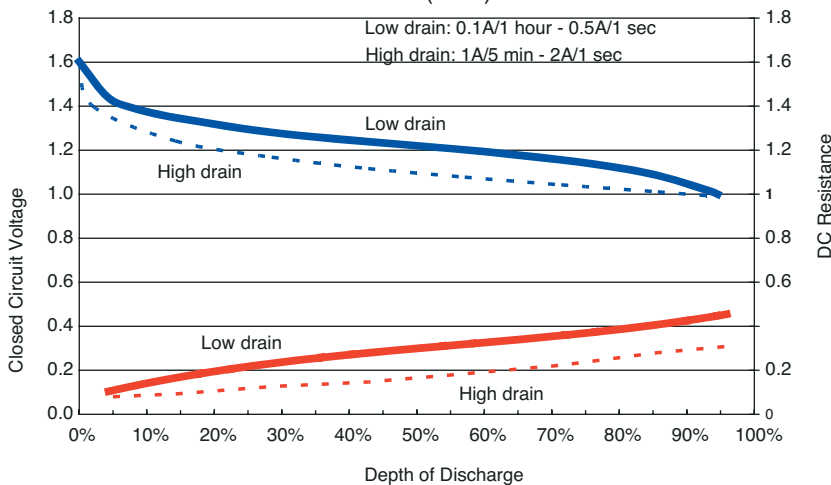

DURACELL[®]
BATTERIES

Berkshire Corporate Park
Bethel, CT 06801 U.S.A.
Telephone: Toll-free 1-800-544-5454
Internet: www.duracell.com

* Delivered capacity is dependent on the applied load, operating temperature and cut-off voltage. Please refer to the charts and discharge data shown for examples of the energy / service life that the battery will provide for various load conditions.