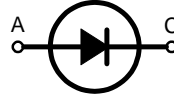
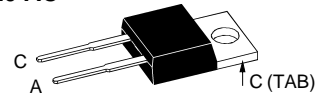

Rectifier Diode

$V_{RRM} = 800-1600\text{ V}$
 $I_{F(AV)M} = 30\text{ A}$

| V_{RSM} V | V_{RRM} V | TO-220 | TO-263 |
|----------------|----------------|------------|-------------|
| 900 | 800 | DSI 30-08A | DSI 30-08AS |
| 1300 | 1200 | DSI 30-12A | DSI 30-12AS |
| 1500 | 1400 | DSI 30-14A | DSI 30-14AS |
| 1700 | 1600 | DSI 30-16A | DSI 30-16AS |

TO-263 AA

TO-220 AC

A = Anode, C = Cathode, TAB = Cathode

| Symbol | Conditions | Maximum Ratings | |
|--------------|--|-----------------|------------------|
| $I_{F(AV)M}$ | $T_C = 95^\circ\text{C}; 180^\circ\text{ sine}$ | 30 | A |
| I_{FSM} | $T_{VJ} = 45^\circ\text{C}; t = 10\text{ ms (50 Hz), sine}$ | 300 | A |
| | $V_R = 0\text{ V}; t = 8.3\text{ ms (60 Hz), sine}$ | 330 | A |
| I^2t | $T_{VJ} = 150^\circ\text{C}; t = 10\text{ ms (50 Hz), sine}$ | 270 | A |
| | $V_R = 0\text{ V}; t = 8.3\text{ ms (60 Hz), sine}$ | 300 | A |
| I^2t | $T_{VJ} = 45^\circ\text{C}; t = 10\text{ ms (50 Hz), sine}$ | 450 | A ² s |
| | $V_R = 0\text{ V}; t = 8.3\text{ ms (60 Hz), sine}$ | 460 | A ² s |
| T_{VJ} | $T_{VJ} = 150^\circ\text{C}; t = 10\text{ ms (50 Hz), sine}$ | 365 | A ² s |
| | $V_R = 0\text{ V}; t = 8.3\text{ ms (60 Hz), sine}$ | 380 | A ² s |
| T_{VJM} | | -40...+150 | °C |
| T_{stg} | | 150 | °C |
| M_d | Mounting torque | 0.4...0.6 | Nm |
| Weight | | 2 | g |

Features

- International standard packages
- JEDEC TO-263 AA surface mountable
- Planar passivated chips
- Epoxy meets UL 94V-0 flammability classification

| Symbol | Conditions | Characteristic Values | |
|------------|--|-----------------------|-----|
| I_R | $T_{VJ} = T_{VJM}; V_R = V_{RRM}$ | ≤ 1 | mA |
| V_F | $I_F = 45\text{ A}; T_{VJ} = 25^\circ\text{C}$ | ≤ 1.45 | V |
| V_{T0} | For power-loss calculations only | 0.85 | V |
| r_T | $T_{VJ} = T_{VJM}$ | 13 | mΩ |
| R_{thJC} | DC current | 1.0 | K/W |

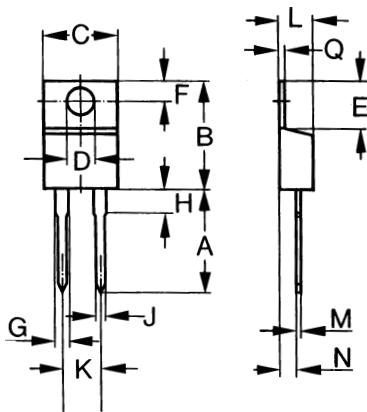
TO-220 Outline

| Dim. | Millimeter | | Inches | |
|------|------------|-------|--------|-------|
| | Min. | Max. | Min. | Max. |
| A | 12.70 | 14.73 | 0.500 | 0.580 |
| B | 14.23 | 16.51 | 0.560 | 0.650 |
| C | 9.66 | 10.66 | 0.380 | 0.420 |
| D | 3.54 | 4.08 | 0.139 | 0.161 |
| E | 5.85 | 6.85 | 0.230 | 0.420 |
| F | 2.54 | 3.42 | 0.100 | 0.135 |
| G | 1.15 | 1.77 | 0.045 | 0.070 |
| H | - | 6.35 | - | 0.250 |
| J | 0.64 | 0.89 | 0.025 | 0.035 |
| K | 4.83 | 5.33 | 0.190 | 0.210 |
| L | 3.56 | 4.82 | 0.140 | 0.190 |
| M | 0.38 | 0.56 | 0.015 | 0.022 |
| N | 2.04 | 2.49 | 0.080 | 0.115 |
| Q | 0.64 | 1.39 | 0.025 | 0.055 |

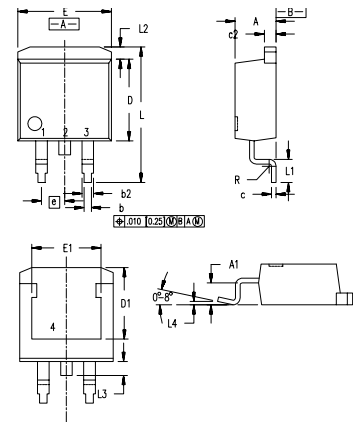
TO-263 AA Outline

| Dim. | Millimeter | | Inches | |
|------|------------|-------|--------|------|
| | Min. | Max. | Min. | Max. |
| A | 4.06 | 4.83 | .160 | .190 |
| A1 | 2.03 | 2.79 | .080 | .110 |
| b | 0.51 | 0.99 | .020 | .039 |
| b2 | 1.14 | 1.40 | .045 | .055 |
| c | 0.46 | 0.74 | .018 | .029 |
| c2 | 1.14 | 1.40 | .045 | .055 |
| D | 8.64 | 9.65 | .340 | .380 |
| D1 | 7.11 | 8.13 | .280 | .320 |
| E | 9.65 | 10.29 | .380 | .405 |
| E1 | 6.86 | 8.13 | .270 | .320 |
| e | 2.54 | BSC | .100 | BSC |
| L | 14.61 | 15.88 | .575 | .625 |
| L1 | 2.29 | 2.79 | .090 | .110 |
| L2 | 1.02 | 1.40 | .040 | .055 |
| L3 | 1.27 | 1.78 | .050 | .070 |
| L4 | 0 | 0.38 | 0 | .015 |
| R | 0.46 | 0.74 | .018 | .029 |

Data according to IEC 60747 and refer to a single diode
 IXYS reserves the right to change limits, test conditions and dimensions

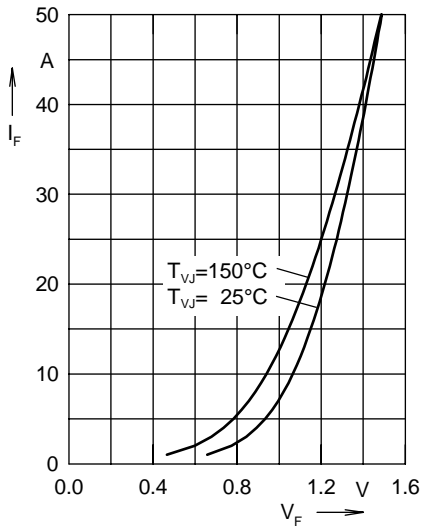

Fig. 1 Forward current versus voltage drop per diode

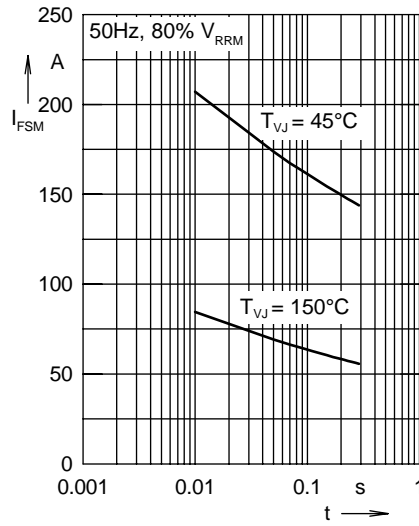

Fig. 2 Surge overload current

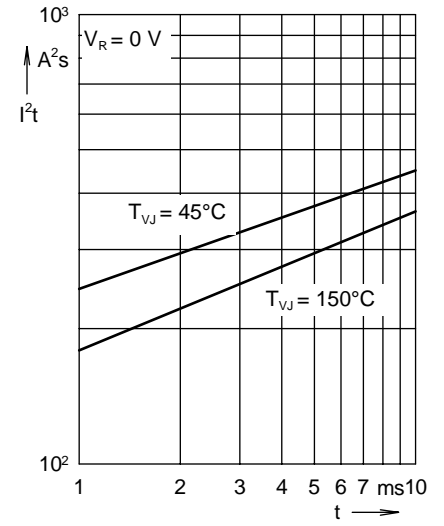

Fig. 3 I^2t versus time per diode

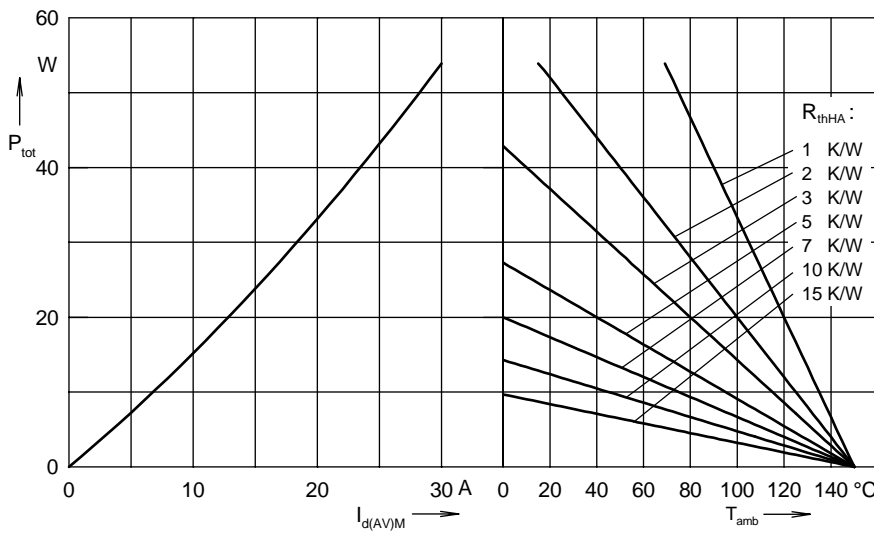

Fig. 4 Power dissipation versus direct output current and ambient temperature, sine 180°

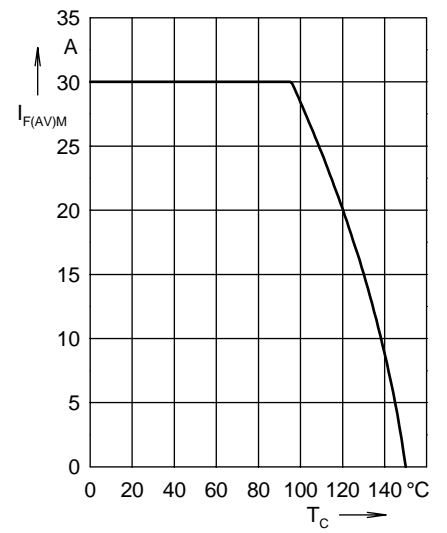

Fig. 5 Max. forward current versus case temperature

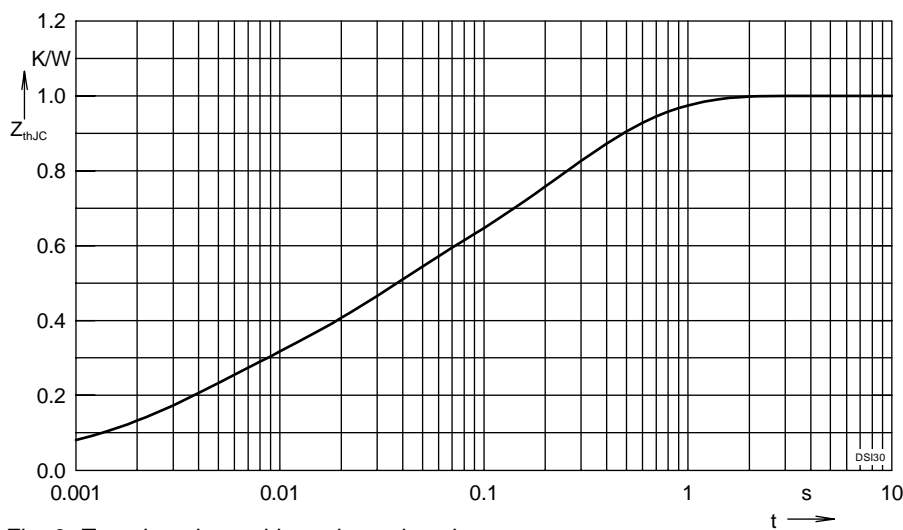

Fig. 6 Transient thermal impedance junction to case

Constants for Z_{thJC} calculation:

| i | R_{thi} (K/W) | t_i (s) |
|---|-----------------|-----------|
| 1 | 0.01362 | 0.0001 |
| 2 | 0.1962 | 0.00316 |
| 3 | 0.267 | 0.023 |
| 4 | 0.3052 | 0.4 |
| 5 | 0.218 | 0.15 |