



Mooz-3 Operation Instruction

Contents

I. Fast Assembly

1.1. Mooz-3	1
-------------------	---

II. Operation Panel

2.1. Home Page	4
2.2. File Directory Interface	4
2.3. Motion Control Interface	4
2.4. Functional Module Control Interface	5
2.5. Color Mixing Configuration Interface	5

III. 3D Printing

3.1. 3-Point Leveling	5
-----------------------------	---

3.2. Set the Zero Point	7
3.3. Install the Filament	8
3.4. Use the Slice Software	8
3.4.1. Install the Slice Software	9
3.4.2. Configuration for Initial Use	9
3.4.3. Online Printing	10
3.4.4. Configuration of Color Mixing Pattern	12
3.4.5. Offline Printing	13
FAQ	14
Parameters	15

Symbol Description

	Description
Basic terms or reference information.	

	Note
Important precaution: ignoring it may cause malfunction of the machine and the corresponding risk.	

	Warning
Important warning: rules must be strictly observed, otherwise it may cause machine breakdown and personal injury.	



Note: Updated Firmwares, User Manuals, Softwares and Tutorial Videos will be uploaded to our official website www.dobot.cc constantly, please use them for better experience. Any support, please contact us: mooz@dobot.cc.



Warning:

Some instructions which have been proofed wrong in the the print version user manual you recieved:

1. Section 1.1.3, the printer head control board mounting position has changed since the cables are not long enough to fit the original mounting position.
2. Suggested nozzle temperature is 230 C for color mixing printing, to reduce risk of nozzle clogging.
3. Reducing printing speed to 30mm/min or lower can get better print results.

1.1 Mooz-3 Accessories List

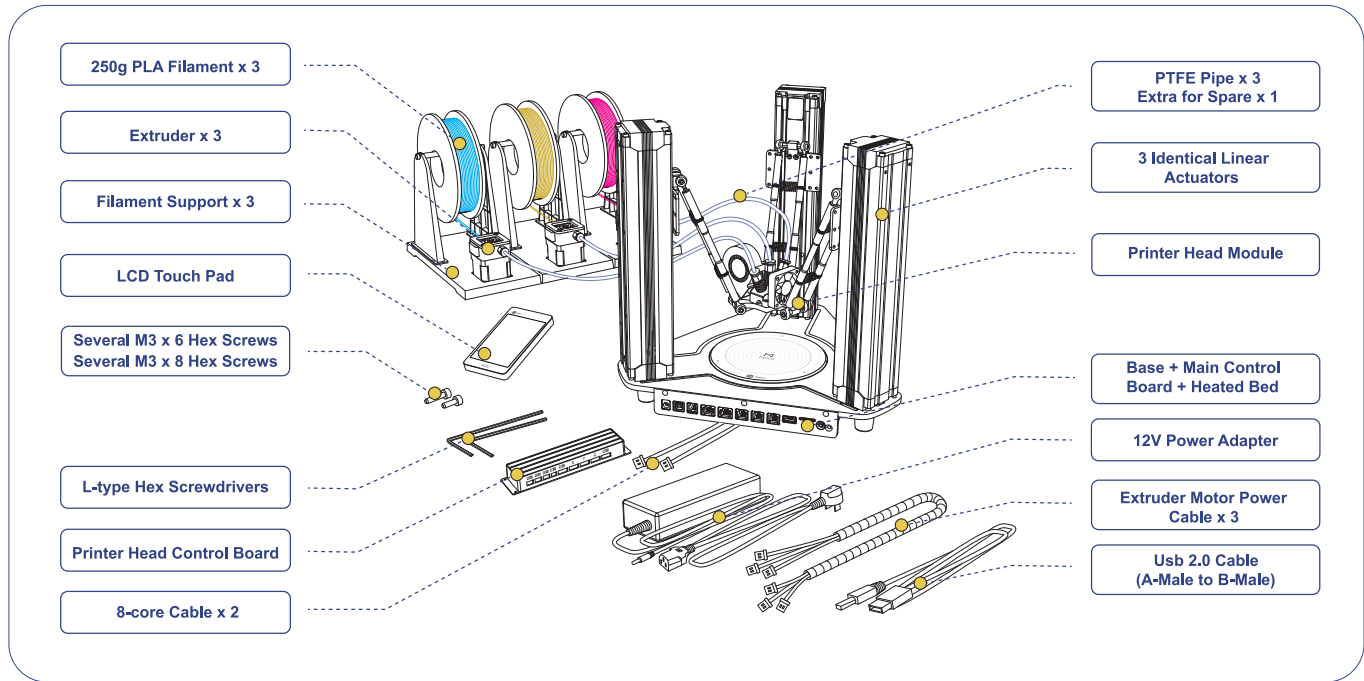

1.1.1 Install the Linear Actuators

Place the base with upside down, run the cable of each linear actuator out through the square hole, and fix the linear actuator on the base with screws (M3x8 hex screw x18), and then fix the cables with clips. As shown below

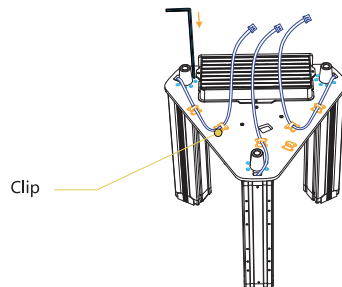
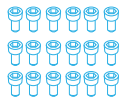

Clip



Note: The linear actuators are identical, which are differentiated into X, Y, Z by mounting positions.

1.1.2 Install the Printer Head Module

Push the sliding plate of each linear actuator upward to the end, fix the printer head module on the sliding plates with screws (M3x6 hex screw x12), Pay attention to the following notes before installing any screws! As shown below

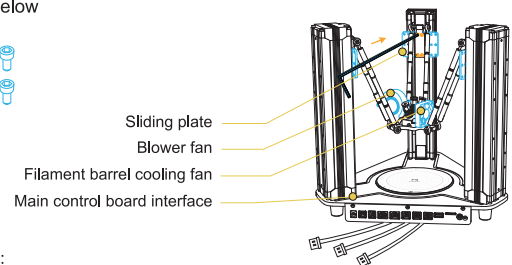

Note:

1. The printer head module should be placed in the right direction, which can be decided by the direction of the fans to the main control board interface.
2. M3x6 screws should be used to fix the printer head, since the m3x8 ones are too long and will cause interference.
3. Please install all the screws without tightening at first, so that the printer head can self-adjust by gravity, and then tighten the screws orderly.

1.1.3 Install the Printer Head Control Board

Fix the printer head control board on the farmost (to the main control board) linear actuator with screws (M3x6 hex screw x3). As shown below

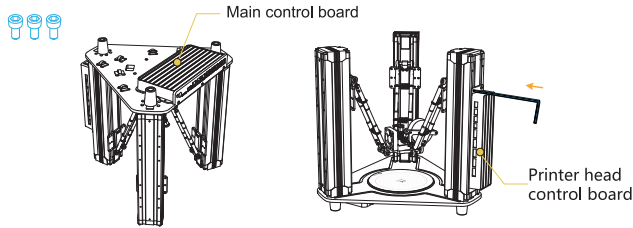

1.1.5 Install the PTFE Pipes

Insert the PTFE pipe to the bottom of the filament barrel, do the same to the remaining PTFE pipes. As shown below

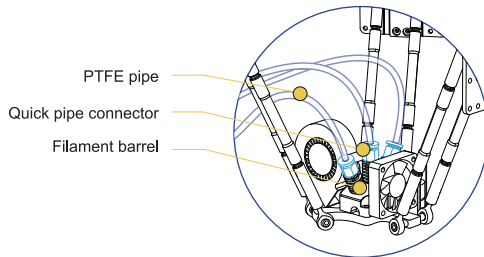

Note:

Please make sure the PTFE pipe has been inserted to the bottom of the filament barrel, otherwise it will cause clogging problem. Inserting with the quick pipe connector removed can make the process easier. The filament barrel and nozzle are sealed with gasket, lost of it will cause filament leaking problem, so do not disassemble the filament barrel unless it is necessary.

1.1.7 Install the Springs

Install the springs, and check and make sure all screws (12 in total) of the linkages are well tightened. As shown below



Spring x6

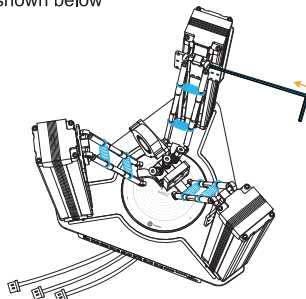

Note: Pull the printer head with hand gently to check for lossness and diastema after check and tightening, lossness and diastema will affect printing accuracy.

1.1.4 Install the Filament Support

Set up the filament support, and place the filament on it. As shown below

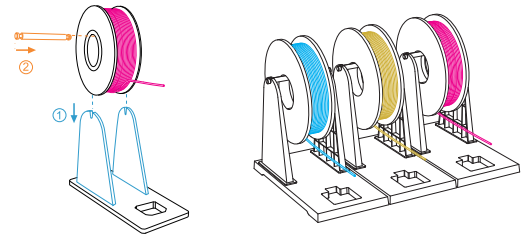

1.1.6 Connect the PTFE Pipes to Extruders

Insert the other end of PTFE pipe into the extruder as far as you can to make filament installation easier, as long as it won't interfere the gear and bearing. Place the extruder on the filament support orderly after proper connecting, make sure PTFE pipes are not crossed. As shown below

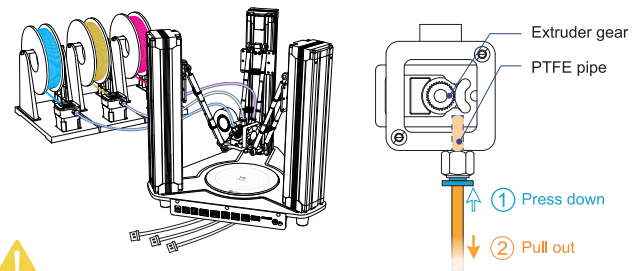

Note:

In case the PTFE pipe and pipe connector need to be detached: Press down the plastic part of the connector and pull the pipe out quickly (see the illustration at top-right). Insert the pipe a few centimeters further first can make the process easier.

1.1.8 Install Extruder Motor Power Cables

Connect the extruders to the corresponding ports of the printer head control board with cables. As shown below

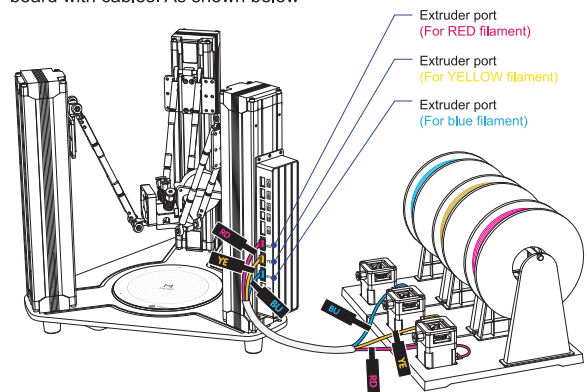

1.1.9 Connect Cables to Main Control Board



Warning: Wrong connection of cables may cause burnout of control board! Hot-plug is strictly prohibited! Always Make sure that all cables are plugged in place before power-on! Plugging of cables during power-on status will cause malfunction!

Before power on the machine, please follow the chart below and connect all cables to the main control board correctly.

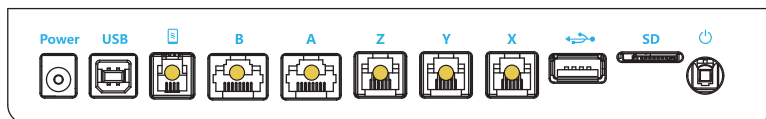

← LCD touch pad

A ← 8-core cable → Port A on printer head control board

B ← 8-core cable → Port B on printer head control board

Z ← Linear actuator on left side of main control board

Y ← Linear actuator on oppsite side of main control board

X ← Linear actuator on right side of main control board

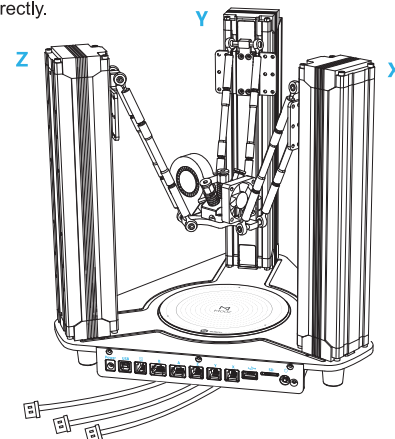

Note: The linear actuators are labeled with X, Y, Z based on mounting positions in the above drawing, which should be connected to the corresponding port on main control board correctly! The 8-core cables are fixed crosswise on the bottom of the base with tape, which are used to connect the main control board and printer head control board, see Section 1.1.10 for more details.

1.1.10 Connect Cables to Printer Head Control Board



Warning: Wrong connection of cables may cause burnout of control board! Hot-plug is strictly prohibited! Always Make sure that all cables are plugged in place before power-on! Plugging of cables during power-on status will cause malfunction!

Before power on the machine, please follow the chart below and connect all cables to the printer head control board correctly.

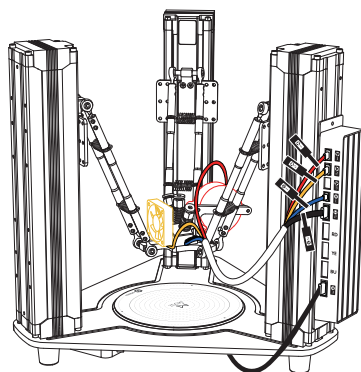

blower fan port
 Filament barrel cooling fan port
 Reserved fan port
 Temperature sensor port
 Heating rod port
 Extruder port
 (For RED filament)
 Extruder port
 (For YELLOW filament)
 Extruder port
 (For blue filament)
 Heated bed port

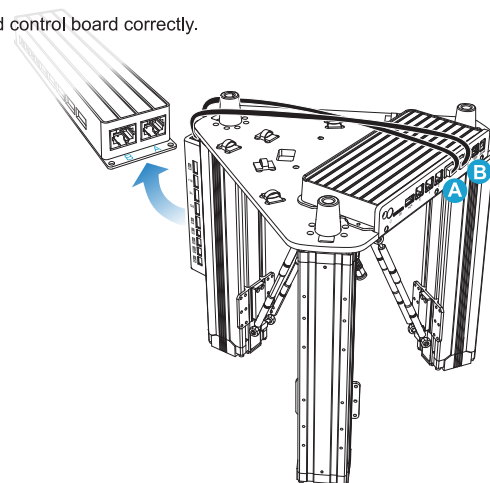



Operation Panel

2.1 Home Page

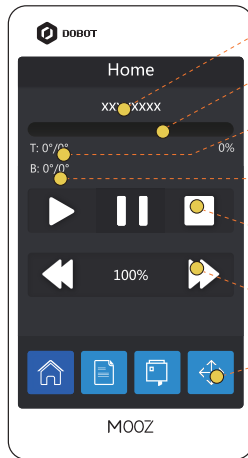

- Display file currently being executed
- Display execution progress of current file
- Display current nozzle temperature
- Display current temperature of heated bed
- Work process control buttons:** Continue, Pause and Abort (in order)
- Real-time working speed control buttons:** left "-" and right "+"
- Interface switching buttons:** (in order) Home page, File directory interface, Functional module control interface, Motion control interface

2.2 File Directory Interface

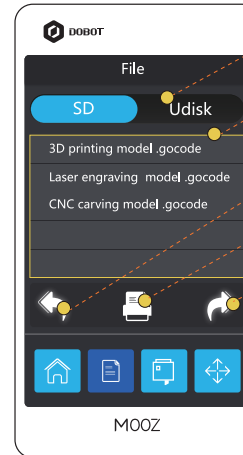

- SD card and U disk switching buttons
- Display supported Gcode files in the current disk (SD / U)
- Page backward
- File execution button:** After selecting the file, click the button to start printing
- Page forward

2.3 Motion Control Interface

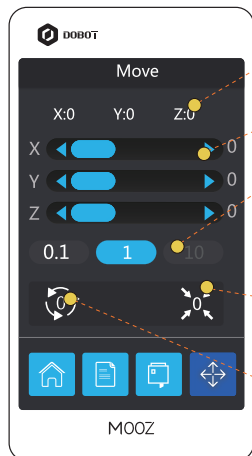

- Display current coordinates
- Motion control scroll bars and buttons**
- Step distance switching buttons:** It should be used along with the motion control buttons, indicating the moving distance of linear actuators when the motion control button is pressed (0.1mm/1mm/10mm)
- Zero point set button:** Record the zero point of machine. It can also be used to enter 3-point leveling mode after power on
- Home button:** After the button is pressed, the machine will start initializing movements and reset



Motion control scroll bar: For quick and rough position adjusting

Module motion control button: It should be used along with the step distance switching buttons

2.4 Functional Module Control Interface

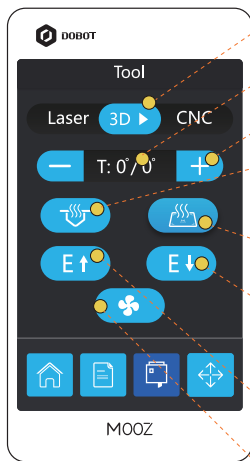

- Color mixing configuration interface entrance button**
- Display current temperature of nozzle / heated bed**
- Set target temperature +/-**
- Nozzle heating:** For testing whether the nozzle heating is normal, press again to stop heating
- Heated bed heating:** For testing whether the bed heating is normal, press again to stop heating
- Filament feed button:** For installing filament and testing extrusion performance, provided that the nozzle is preheated to about 200°C,
- Filament retraction button:** For removing filament, provided that the nozzle is preheated to about 200°C
- Cooling fan switch:** For detecting whether the blower fan is normal

2.5 Color Mixing Configuration Interface

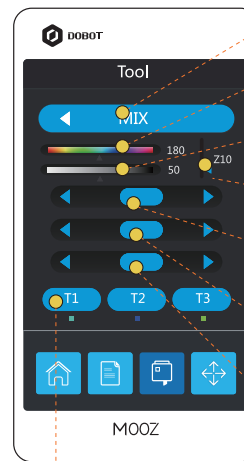

- Color mixing configuration interface exit button**
- Color bar:** Indicating current color being selected
- Color intensity:** Indicating intensity being applied to selected color
- Color mixing cycle:** Indicating current color mixing color cycle being selected
- Color adjusting bar and buttons:** For adjusting and selecting color you desired
- Color intensity adjusting bar and buttons:** For adjusting and applying intensity to the selected color
- Color mixing cycle adjusting bar and buttons:** For adjusting and applying color mixing cycle (corresponds to height of model to be print) you desired
- Color recording buttons :** For recording the selected color. Normally, T1 indicates mixing cycle starting color, T2 indicates cycle midway color, and T3 indicates cycle end color

3D Printing

3.1 3-Point Leveling

Please follow the guide of the machine to record three different points to define a plane parallel to the heated bed, these three points must be recorded in order with nozzle in the areas shown in the drawing below, one in each. The calibration requires to be set only for the first use.

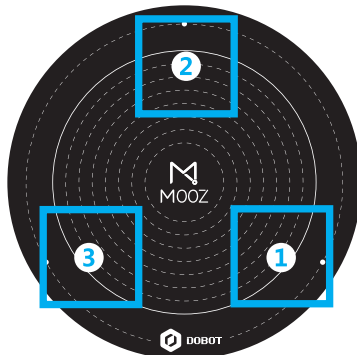

Operation steps:

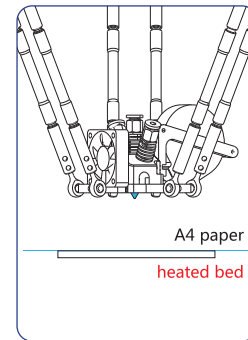
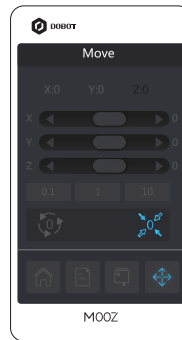
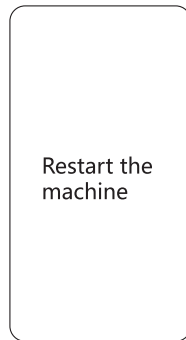

Click the “zero point set button” to enter 3-point leveling mode, and the nozzle will automatically go to a position right above **Point ①**

Place a piece of A4 paper on the heated bed

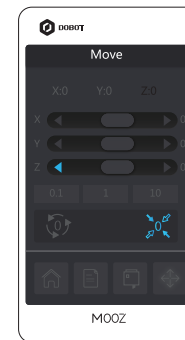
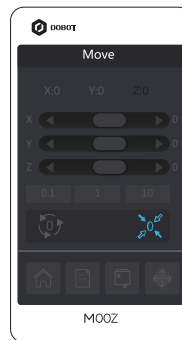
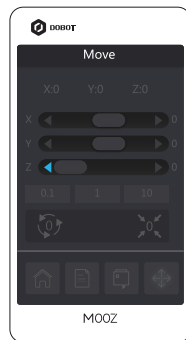

Click the “Z-axis motion control button” to get the nozzle closer to the heated bed, and move the A4 paper back and forth at the same time. Stop just when the paper can slip with slight friction

Click the “zero point set button” to record **Point ①**. The nozzle will automatically go to a position right above **Point ②** after successful recording

Do the same height adjusting and point recording steps to record **Point ②** and **③**. After successful leveling, the machine will home again and exit 3-point leveling mode



Warning: Always Make sure that all cables are plugged in place before power-on! Plugging of cables during power-on status will cause malfunction!



- Note: 1. Mooz-1 , Mooz-2 and Mooz-3 share the same main control board but different firmwares. If your Mooz-3 is transformed from Mooz-1 or Mooz-2, please access to www.dobot.cc to download and upgrade the mainboard firmware!
- 3-point leveling mode can only be entered with 3D printing head connected and by restarting the machine and clicking the “zero point record button” before any homing clicks, and exited after recording the third point.
 - The recorded points will not be lost after power-off. But, once entering 3-point leveling mode, previously recorded points will be cleared automatically.
 - Friction status of the three points should be as uniform as possible. Pay attention when traveling the head downward, especially when the nozzle is getting too close to the bed. Even though the height detect protection will take effect and force the machine to go 0.06mm every click, the heated bed may also get burnt if you continuously move it downward without testing the height with a piece of paper.
 - Only Z coordinate will be recorded, so all you need to do is adjusting the height with a piece of paper. Small adjusting of X/Y is OK if the default point is already burnt a hole due to misoperation and makes the height hard to test.
 - A re-assembled machine should be re-levelled.

3.2 Set the Zero Point

Zero point is the start point for the machine to print, which requires to be set only for the first use.

Operation steps:

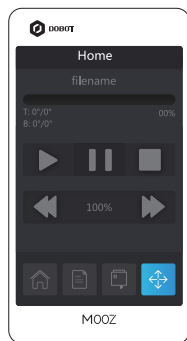

Click the "motion control interface button" to enter the interface

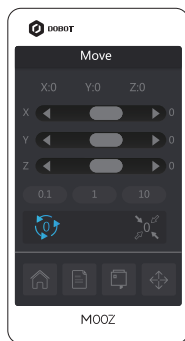

Click the "home button" and wait for the machine to be reset

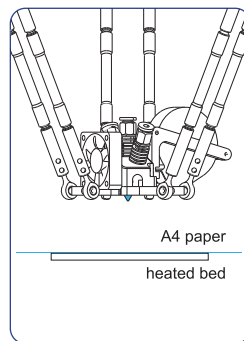

Place a piece of A4 paper on the heated bed

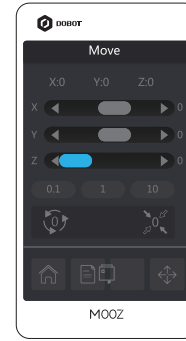

Move the "scroll bar of Z-axis" to the leftmost

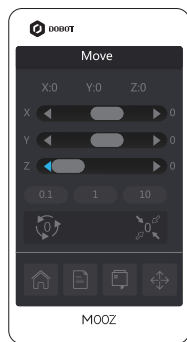

Continue to click the "motion control button" to get the nozzle closer to the heated bed, and move the A4 paper back and forth at the same time. Stop just when the paper can slip with slight friction.

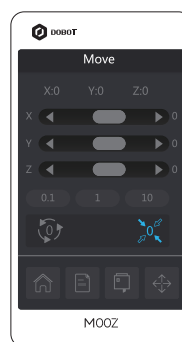
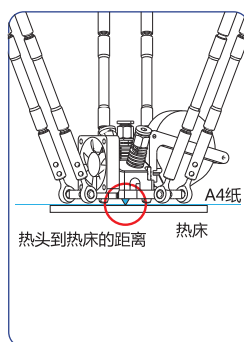

Click the "zero point set button" to record the position of zero point. The machine will home again after successful recording.



- Note:
1. Only the zero of Z-axis need to be set and recorded. Zeros of X-axis and Y-axis are system default values and will not be recorded.
 2. Too high Z-axis zero position will lead to loose bonding at the bottom, causing the model falling off, and too low position will make it difficult to take off the model or even scratch the heated bed. Dedicated fine tuning is always required to obtain satisfactory first several layers.
 3. The zero point will not be lost after power-off, so there's no need to reset it. However, the zero point may be deviated and needs to be reset after the machine is reassembled.
 4. Pay attention when moving the head downward, especially when the nozzle is getting too close to the bed. Even though the height detect protection will take effect and force the machine to go 0.06mm every click, the heated bed may also get burnt if you continuously move it downward without testing the height with a piece of paper.
 5. Please do not click irrelevant buttons to change X/Y coordinates, the zero point will only be successfully recorded with X/Y coordinates remain unchanged 0.
 6. If your printer prints in the mid air, the zero point must be wrongly set. After correct zeroing and homing, the coordinate of Z should be bigger than 100.

3.3 Install the Filament

Operation Steps:

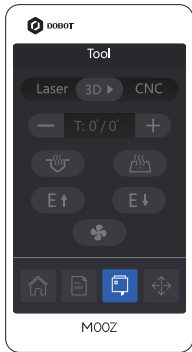

Enter the functional module control interface



Click the "Heat" button of nozzle

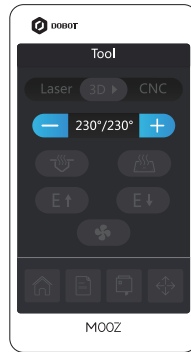

Wait for the temperature to reach about 230°C



Insert the filament into the PTFE pipe (As shown below)



Click "E+" button on the screen until melted filament flows out of the nozzle

Schematic diagram for installing the filament:

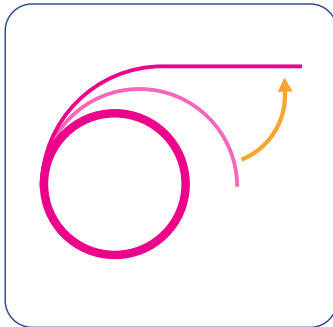

Straighten the filament manually

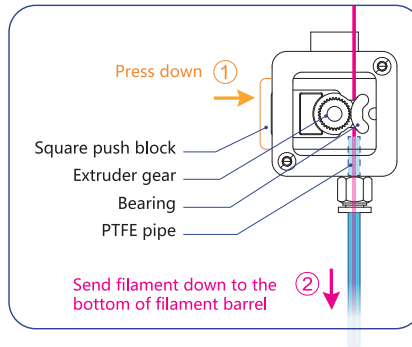

Press down the square push block, insert the filament into PTFE pipe down to the bottom of filament barrel through the gap between extruder gear and bearing

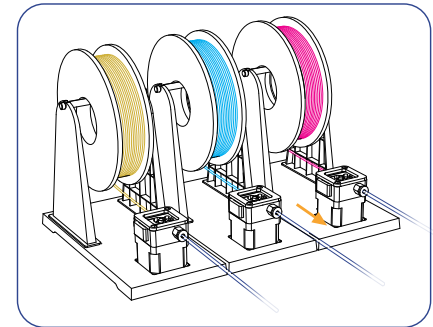

Rearrange the filament rolls and extruders



- Note: 1. If one or some of the extruder motors produce loud sound of step losing after clicking the "E+" button, please check whether the nozzle has been heated to target temperature. Clogging issue may also result in motor step losing problem, in this case, please heat the nozzle to the target temperature, pull out the filament, remove the swelling end and reinstall it.
2. Wrong slicing parameter or too low zero point will also cause motor step losing, please decide according to actual situation.

3.4 Use the Slice Software



Description: Mooz supports most third-party printing softwares, such as: Cura, Repetier-Host, etc. Cura 3.1.0 is described here as an example.

3.4.1 Install the Slice Software

Operation steps:

- ① Double-click  to install the software:
Cura3.1.0.exe

- ② Select the installation directory, it is recommended to keep the default, click "Next":

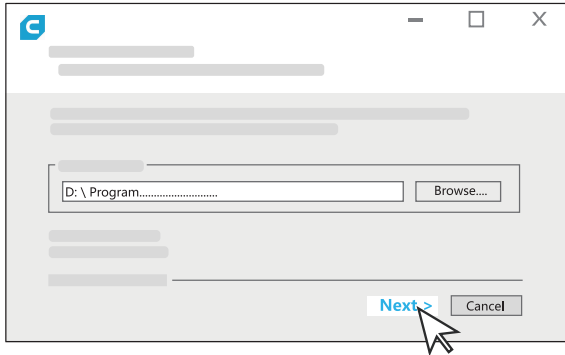

- ③ Select the features you need, it is recommended to keep the default, click "Install":

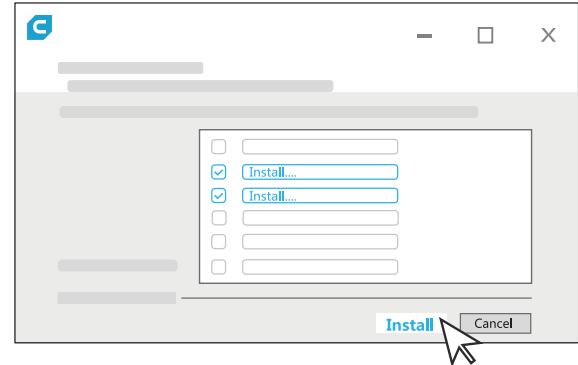

- ④ The window of installing arduino driver will pop up in the process of installation, follow the prompts to complete the installation.

3.4.2 Configuration for Initial Use



Description: Please visit www.dobot.cc to download the related tutorial videos and softwares.

Operation steps:

- ① Run Cura 3.1.0 and go "Settings" > "Printer" > "Add Printer" > "Custom", name your printer "Mooz-3", and click "Add printer", dialog of Machine Settings will popup



- ② Configure the machine

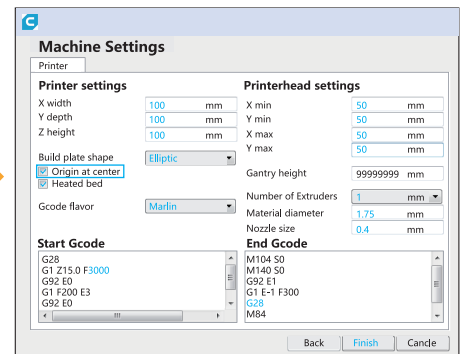
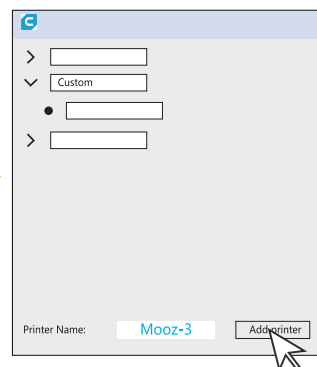
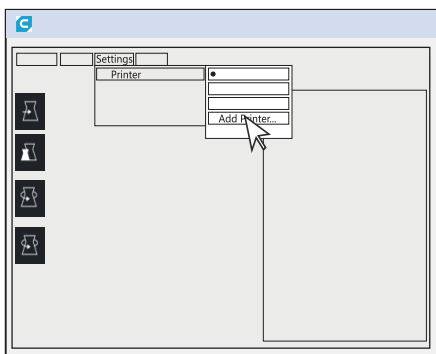

Note: Origin of Mooz3 is defaulted in the middle of the heated bed, please be sure to check the "Origin at center" box, otherwise the machine will not work normally.

3.4.3 Online Printing



- Note: 1. Please make sure the machine has been properly linked to your PC, power it on before starting Cura. Your computer may need to install extra driver, please access to www.dobot.cc to download it.
2. If the computer enters sleep mode during online printing, the printing process will be interrupted. Please check the power status of the computer before printing.

Operation steps:

- ① Connect to the computer with USB cable, and power up the machine

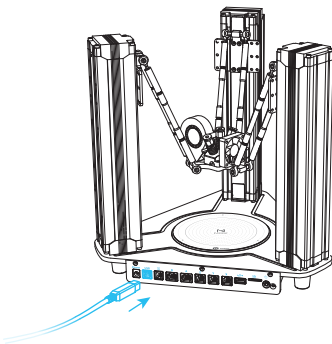

- ② Restart Cura 3.1.0, and select the printer you added and configured in Section 3.4.2

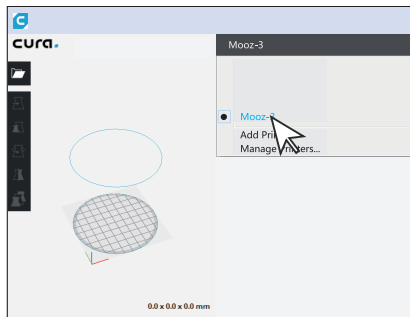

- ③ Go "File" > "Open File(s)..." and select the model you want to slice. Cura supports STL/OBJ /AMF format models

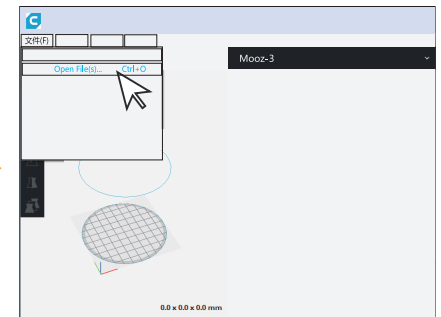

Profile the model:

- ① Adjust the model: left click on the model, four options "Fit", "Zoom", "Rotate" and "Translate" will appear on the left side of the interface, you can adjust as needed.

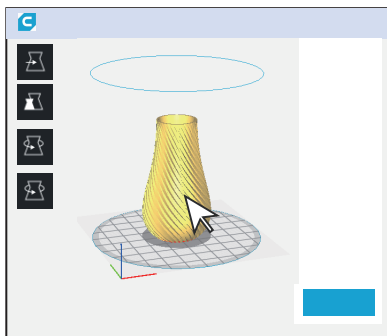

- ② View the details of the slice: click the drop-down list on the upper middle corner of the interface and select "Layer view" to view the details of the slice.

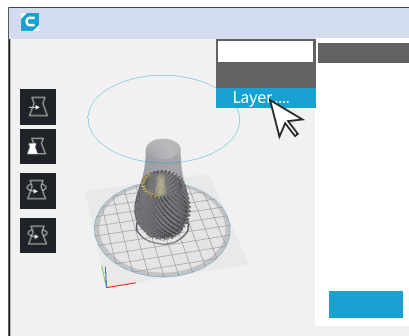

- ③ Click the drop-down list on the right bottom corner of the interface and select "Print via USB".

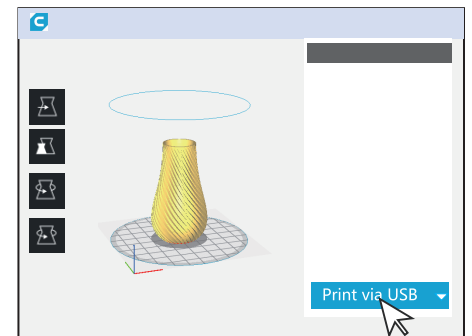



Description of key profile settings:

- ① **Layer Height:** for the height of each layer of printing, smaller value will produce finer surface, but cost more printing time. Suggested range is 0.05 to 0.3, not exceeding 3/4 of the diameter of the nozzle. Mooz used 0.4 nozzle, not exceeding 0.3.
- ② **Wall Thickness:** for the printing thickness of the outer surface of the model, the setting of 0.8 indicates that the outer surface will go two rounds, since the width of each round equal to the diameter of the nozzle, namely 0.4.
- ③ **Top/Bottom Thickness:** determine the bottom/top thickness of the model.
- ④ **Infill Density:** determine the filling density of the internal grid of the model, generally set at 15% or less.
- ⑤ **Printing Temperature:** need to be set according to filament type. Suggested value for PLA is 190~230 C; and for ABS is 230~260 C.
- ⑥ **Build Plate Temperature:** need to be set according to filament type. Suggested value for PLA is 50~70 C; and for ABS is 80~100 C.
- ⑦ **Support Placement:** If the model has any hovering part, the option must be switched on. Generally "Everywhere" indicates that support can be added on the model itself. If you select "Touching buildplate", it indicates that support can be added only between the print platform and the model hovering position, not on the model.
- ⑧ **Build Plate Adhesion:** "Brim" indicates that a few layers of outer ring should be added on the bottom edge of the model so as to prevent warping. And "Raft" is used to ge the whole model raised by adding a raft-like base on the bottom when the heated bed leveling status is not satisfying.
- ⑨ **Spiralize Outer Contour** (i.e., vase mode): only the outer surface and the bottom of the model are printed, and continuous spiral lift will appear when printing the outer surface, which can improve the surface quality, but has requirements for the model, and that is, the model can only have one outer surface and can not be hovered.



Note: 1. Hover the mouse over the option, and the corresponding hint will appear.
2. Right-click anywhere within the parameter setting area, you can "Configure setting visibility ...".

Mooz-1&2

Material: PLA

Printer Setup Recommended Custom

Profile: Fine 0.1mm ★ ▼

Layer Height 0.12 mm

Shell ▼

Wall Thickness 1.2 mm

Top/Bottom Thickness 1.2 mm

Infill ▼

Infill Density 20 %

Infill Pattern Grid ▼

Gradual Infill Steps 0

Material ▼

Printing Temperature 230 °C

Build Plate Temperature 60 °C

Diameter 1.75 mm

Flow 100 %

Enable retraction

Retraction Distance 6 mm

Retraction Speed 50 mm/s

Speed ▼

Print Speed 40 mm/s

Infill Speed 40 mm/s

Wall Speed 20 mm/s

Travel speed 50 mm/s

Cooling <

Support <

Build Plate Adhesion ▼

Build Plate Adhesion Type Raft ▼

Raft Extra Margin 6 mm

Raft Air Gap 0.2 mm

Initial Layer Z Overlap 0.1 mm

Raft Top Layers 4

Raft Print Speed 15 mm/s

Special Mode ▼

Print Sequence All at Once

Spiralize Outer Contour

3.4.4 Configuration of Color Mixing Pattern

1. Apply system default color mixing pattern.

MOOZ-3 firmware has configured with default color mixing pattern, you only need to set the color mixing cycle to activate it.



Enter the functional module control interface



Click the "color mixing configuration interface entrance button" to enter the interface



Use the "Color mixing cycle adjusting bar and buttons" to define the mixing cycle

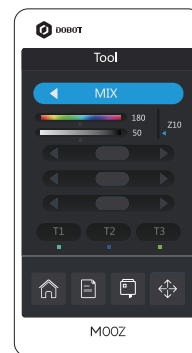

Click the "color mixing configuration interface exit button" to exit the interface

2. Customize color mixing pattern

If you desire to define your own color mixing pattern, please follow the steps below:

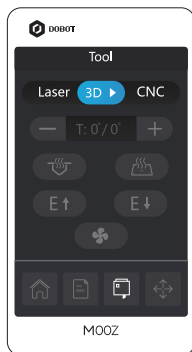

Click the "color mixing configuration interface entrance button" to enter the interface

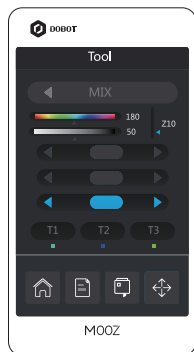

Use the "Color mixing cycle adjusting bar and buttons" to define the mixing cycle



Use the "Color adjusting bar and buttons" and "Color intensity adjusting bar and buttons" to obtain the color you desired, and record it to T1 as cycle starting color



Perform the same steps to define T2/T3 color



Notes: 1. Unit of color mixing cycle is millimeter, corresponds to model height. If you want to apply several mixing cycles to the same model, please decrease the mixing cycle exponentially.

If you keep the color mixing cycle remain default 0, color mixing pattern will not be activated, and the red filament will be selected for printing.

2. Primary filament color (red/yellow/blue) can be recorded to T1/T2/T3 alternately, under the condition of color mixing cycle remain default 0.

3. Normally, T1 indicates mixing cycle starting color, T2 indicates cycle midway color, and T3 indicates cycle end color. The gradual color change process will proceed according to the color bar, if the color recorded to T2 is on the left of color recorded to T1, the gradual color change process will proceed backwards (from right to left). If the same color has been recorded to T1 and T2, or T2 and T3, no gradual color change will happen to the corresponding section. If only two of T1/T2/T3 are defined, the selected two colors will be used as cycle starting color and cycle end color for mixing printing. If only one of T1/T2/T3 is defined, the selected color will be used for printing, no gradual color change will happen. If none of T1/T2/T3 is defined, default color mixing pattern will be activated, under the condition of color mixing cycle is not 0.

4. Click T1/T2/T3 again to clear the recorded color.

5. Customized color mixing pattern will be cleared after restarting the machine.

6. To many retractions will affect color mixing performance, print model with fewer retractions can get better results.

3.4.5 Offline Printing



- Note: 1. The U disk or SD card format shall be Fat32 with the capacity not greater than 32GB.
2. Since 3-in-1-out Broden extruders are adopted, it is recommended to heat the nozzle and bed to the target temperature 230°C, make sure the extruders can feed normally before selecting a file to print. Please remove the overflowing filament before the printing starts.
3. After the printing finished, remove the finished print with knife after the heated bed cools down, please be careful in the process to avoid getting your hands hurt or heated bed scratched.
4. Applying gummed textured paper before printing can greatly reduce risk of getting the heated bed scratched!

Operation steps :

1. Save Gcode file to U disk or SD card with cura.
2. Insert U disk or SD card to the printer.
3. Follow the steps below to execute the Gcode file.

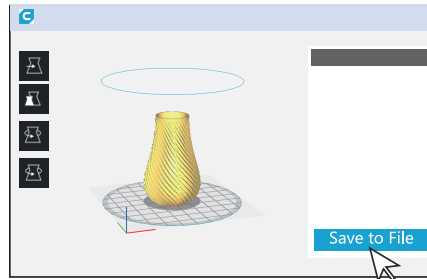

Click the "File" button to enter the file page

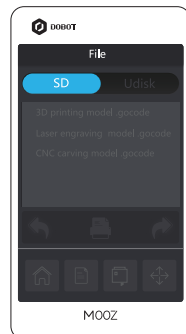

Click to select SD card or U disk

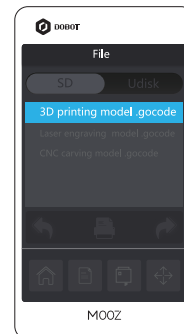

Click to select the file you want to print

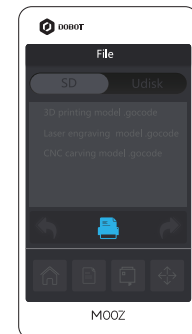

Click the "Print" button to start printing



Wait for the heated bed and nozzle to be heated to the target temperature

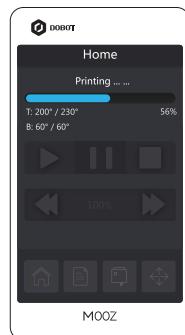

Start printing automatically



Description: During the printing or engraving or carving process, the above buttons can be used to control the working process in real time (Continue, Pause, Abort, Slow Down, Speed Up)

FAQ

Q : No melted filament being extruded from the nozzle

A :

1. Check whether the current temperature is higher than 200°C
2. When printing, the nozzle close to the platform may cause blocking and heated bed scratch. You need to re-adjust the zero point, and keep the distance to be the thickness of a A4 paper
3. Nozzle is clogged, and you need to reinstall the filament
4. It is recommended to use PLA filament, and if other types of filament are used, there may have the risk of blocking

Q : The layer pattern is obvious

A :

1. Reduce the wall speed by using the slice software
2. Reduce the layer height, generally set to 0.2mm, and if the layer pattern is obvious, reduce to 0.1mm
3. Some filament are sensitive to temperature, you can try to reduce 5 to 10 C

Q : The model is involved with serious wiredrawing

A :

1. Increase retraction speed and distance
2. Reduce the wall speed by using the slice software
3. Increase the travel speed
4. Some filament are sensitive to temperature, you can try to reduce 5 to 10 C

Q : Warping or shedding occurs when printing the model of a large area

A :

1. Thermal expansion and contraction of the filament causes warping
2. The first layer is printed too quickly, set the first layer printing speed to about 20mm/s
3. Heated bed temperature is too low
4. If you do not want to use heated bed , you can use textured paper or apply water-soluble PVC solid glue
5. Heated bed is not level
6. Z-axis zero point is set too high
7. The ambient temperature changes too much

Q : The machine is unable to control

A :

1. Check whether the failure occurs in the heating process, and if heating, please wait for the completion of heating, otherwise you can not control the machine
2. Plugging cables after the machine is enabled may cause the failure to control the machine due to locking, restart the machine can fix the problem

Q : The machine can not be heated

A : Plugging cables after the machine is enabled may cause the failure due to locking, restart the machine can fix the problem

Parameters

Overall Dimensions: $\Phi 350 * 325\text{mm}$

Adapter Input: 100-240V~50/60Hz, 1.8Amax

Adapter Output: 12V~10A

Main Material: Aircraft-grade aluminum

Operation Panel: 3.5' LCD touch pad

3D Printing

Nozzle Diameter: 0.4mm

Layer Resolution: 0.05~0.3mm

Nozzle Temperature: 190~260°C

Heated bed Temperature: 50~100°C (at 20°C ambient temperature)

Forming Size: $\Phi 100 * 100\text{mm}$

Applicable Materials: 1.75mm PLA, ABS , PC , FLEX

Printing Speed: 10~100mm/s

Operating Temperature: 0~40°C



Shenzhen Yuejiang Technology Co., Ltd | China
Address: Nanshan District, Shenzhen City
To purchase or learn more, please visit www.dobot.cc