

# HOW TO SOLDER? - HOE SOLDEREN ? - COMMENT SOUDER? - WIE LÖTEN? - ¿CÓMO SOLDAR?

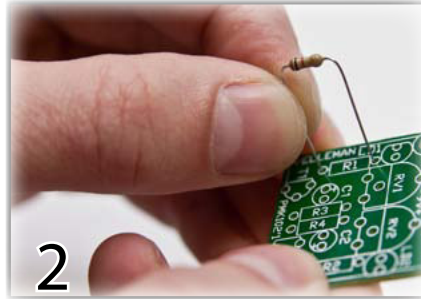

Wipe tip - Reinig de punt - Nettoyez la panne - Reinigen Sie die Spitze - Limpie la punta \*



Insert part against PCB - Monteer het onderdeel tot tegen het printplaatje - Montez le composant contre le circuit imprimé - Montieren Sie das Bauteil bis gegen die Leiterplatte - Ponga la pieza junto al CI

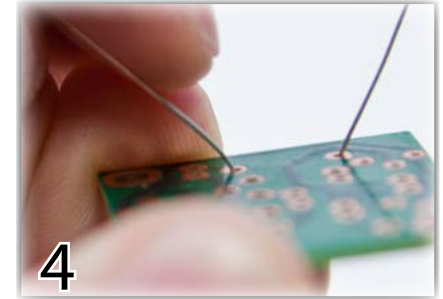
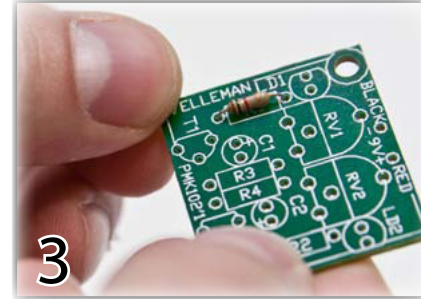

Bend leads - Plooi de aansluitdraden - Pliez les fils de connexion - Biegen Sie das Drahtende um - Pliegue los hilos

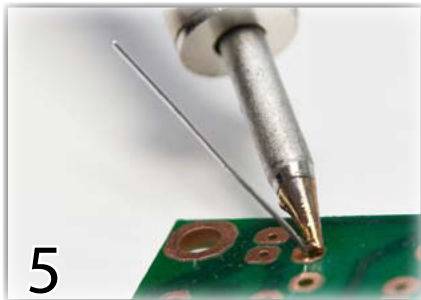

Heat part lead & PCB pad - Verwarm het uiteinde van de aansluitdraad en het printplaatje - Réchauffez l'extrémité du fil de connexion et le circuit imprimé - Erhitzen Sie den Anschlussdraht und die Lötstelle - Caliente una parte del hilo junto a la placa CI

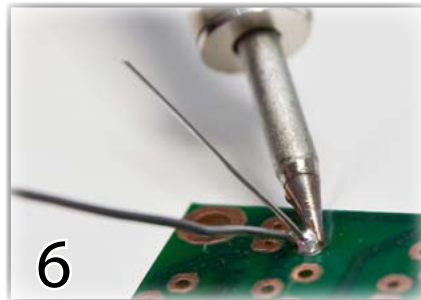

Apply solder - Breng soldeersel aan - Appliquez de la soudure - Führen Sie Lötzinn zu - Haga la soldadura

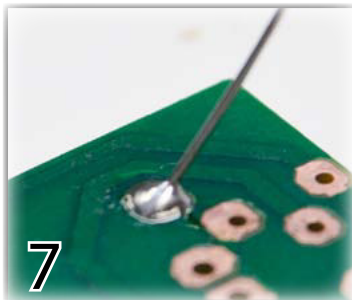

Correct joint - Correcte soldeerverbinding - Joint de soudure correct - Korrekte Lötverbindung - Soldado correcto

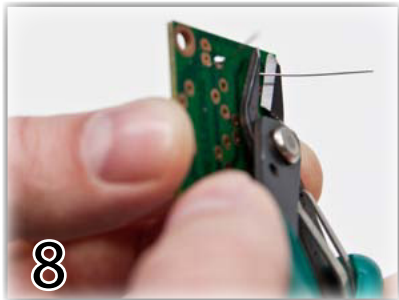

Cut close to PCB - Knip af tot tegen het printplaatje - Coupez jusqu'au bord du circuit imprimé - Zwicken Sie die Anschlussdrähte knapp über den Lötverbindungen ab - Corte cerca de la placa CI



Inspect - Controleer - Vérifiez - Überprüfen Sie - Compruebe la soldadura

## Bad solderings - slechte solderingen - mauvaises soudures - Schlechte Lötstellen - Malas soldaduras

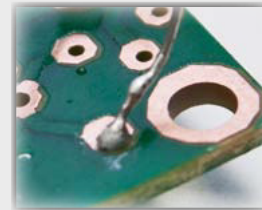

Too little solder - Te weinig soldeersel - Pas assez de soudure - Zu wenig Lot - Poco soldado

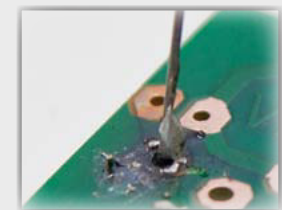

Too much heat - Te warm - Chaleur de soudure trop élevée - Zu warm - Demasiada temperatura

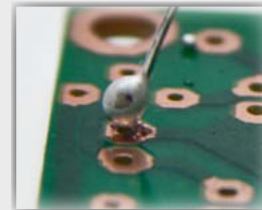

Bad contact - Slecht contact - Mauvais contact - Schlechter Kontakt - Mal contacto

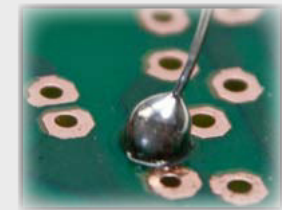

Too much solder - Te veel soldeersel - Trop de soudure - Zu viel Lot - Soldado en exceso

\* not included - niet meegeleverd - non fournie - nicht mitgeliefert - no incluido

**ELECTRONIC CHRISTMAS TREE - KERSTBOOM MET KNIPPERENDE LEDs - SAPIN DE NOËL AVEC LEDs CLIGNOTANTES - WEIHNACHTSBAUM MIT BLINKENDEN LEDs - ÁRBOL DE NAVIDAD CON LEDs INTERMITENTES - ALBERO DI NATALE ELETTRONICO - ÁRVORE DE NATAL A LED's**

**1 Resistor - Weerstand - Résistance - Widerstand - Resistencia - Motstand - Vastus - Resistenze**

R1 ... R4: 1K2 (Brown, Red, Red) - (Bruin, Rood, Rood) - (Brun, Rouge, Rouge) - (Braun, Rot, Rot) - (Brun, Röd, Röd) - (Ruskea, Punainen, Punainen) - (Marrón, Rojo, Rojo) - (Castanho, Encarnado, Encarnado) - (Marrone, Rosso, Rosso)

R5, R6: 82K (Grey, Red, Orange) - (Grijs, Rood, Oranje) - (Gris, Rouge, Oranje) - (Grau, Rot, Orange) - (Grå, Röd, Orange) - (Harmaa, Punainen, Oranssi) - (Gris, Rojo, Naranjado) - (Cinzento, Encarnado, Laranja) - (Grigio, Rosso, Aranciato)

R7, R8: 100K (Brown, Black, Yellow) - (Bruin, zwart, Geel) - (Brun, noir, Jaune) - (Braun, Schwarz, Gelb) - (Brun, Svart, Gul) - (Ruskea, Musta, Keltainen) - (Marrón, Negro, Amarillo) - (Castanho, Preto, Amarelo) - (Marrone, Nero, Giallo)

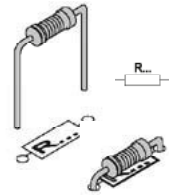

**2 LEDs**

• LD1 ... LD13: 3 mm

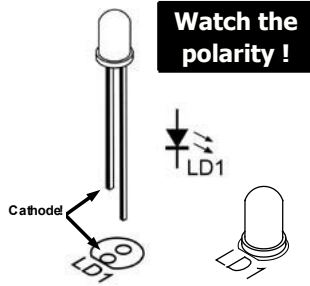

**3 Transistor**

• T1 ... T4: BC547

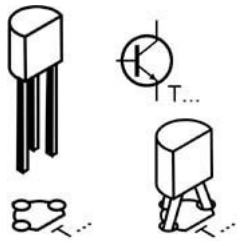

**4 Electrolytic capacitor**

• C1 ... C4: 10µF

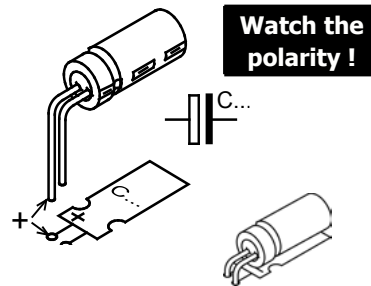

**5 Battery holder**

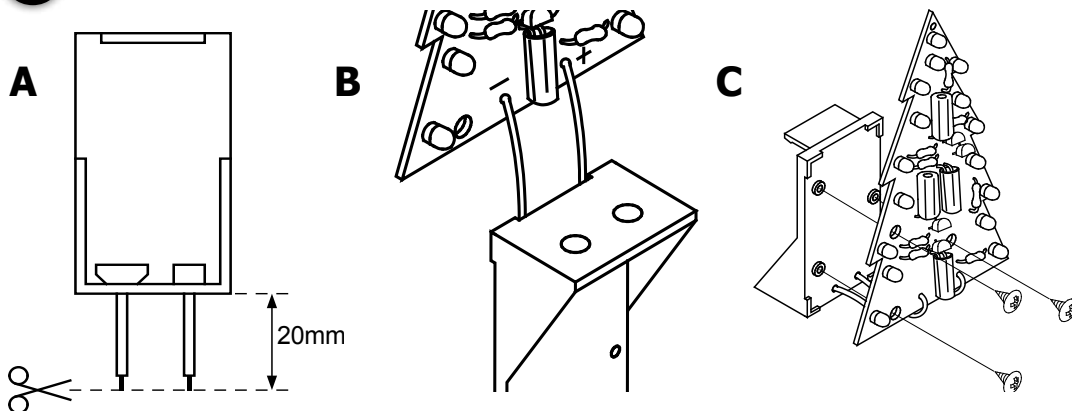

**ELECTRONIC CANDLE - ELEKTRONISCH THEELICHTJE - BOUGIE CHAUFFE-PLAT ÉLECTRONIQUE - ELEKTRONISCHES TEELICHT - VELITA ELECTRÓNICA - CANDELA TEALIGHT ELETTRONICA - VELA CINTILANTE**

**1 Resistor - Weerstand - Résistance - Widerstand - Resistencia - Motstand - Vastus - Resistenze**

Lower side - Componentenzijde  
- Inférieur soie - Niedriger seide  
- Inferior seda

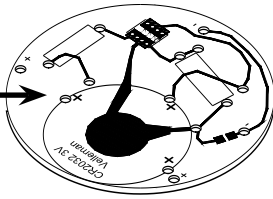

R1: 100

(Brown, Black, Brown) - (Bruin, zwart, Brown) - (Brun, noir, Brun) - (Braun, Schwarz, Braun) - (Brun, Svart, Brun) - (Ruskea, Musta, Ruskea) - (Marrón, Negro, Marrón) - (Castanho, Preto, Castanho) - (Marrone, Nero, Marrone)

R2: 100K

(Brown, Black, Yellow) - (Bruin, zwart, Geel) - (Brun, noir, Jaune) - (Braun, Schwarz, Gelb) - (Brun, Svart, Gul) - (Ruskea, Musta, Keltainen) - (Marrón, Negro, Amarillo) - (Castanho, Preto, Amarelo) - (Marrone, Nero, Giallo)

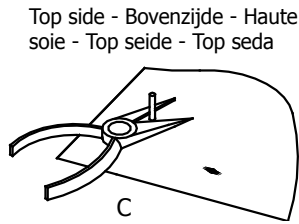
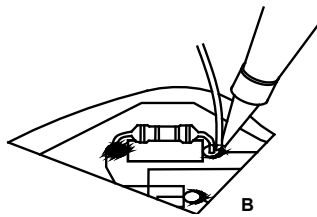
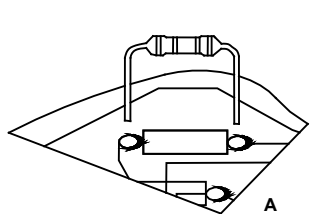
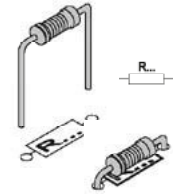

Top side - Bovenzijde - Haute soie - Top seide - Top seda

**2 Battery holder**

solder drop - soldeer druppel  
- goutte de soudure - Lot  
Tropfen - gota de soldadura

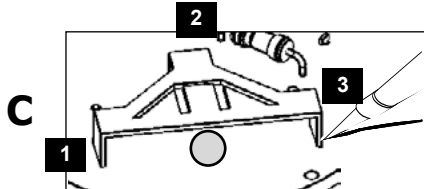
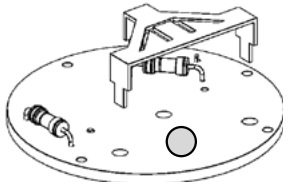
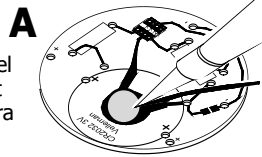

**3 IC**

• IC1: VMK167  
(programmed PIC10F200-I/PG)

Watch the notch!  
Attention à l'encoche!

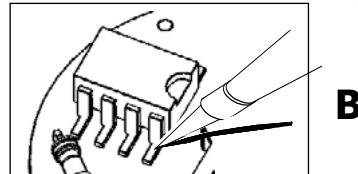
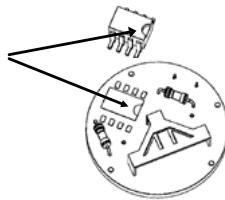
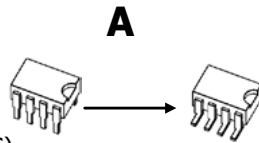

**4 PCB TABS**

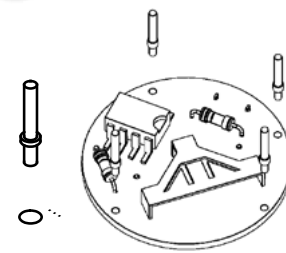

• 4 x

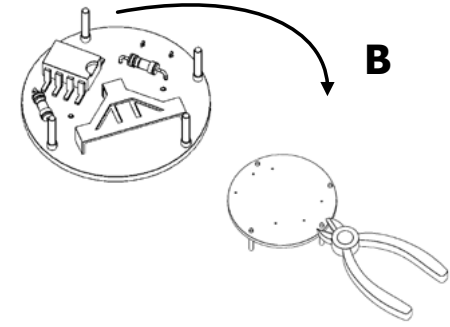
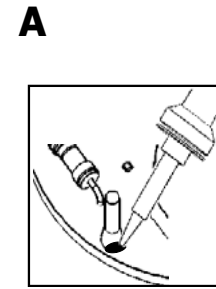

**5 BUTTON**

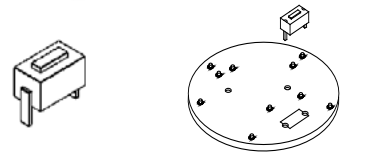

Top side - bovenzijde - haute - top

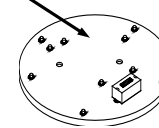

**6 LED**

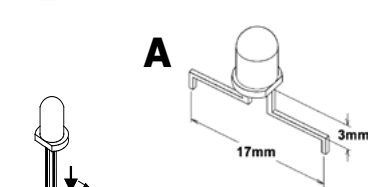

• 5mm yellow LED

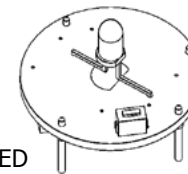



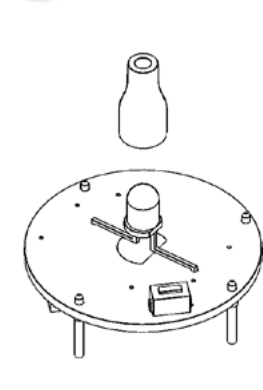

**7 LED**

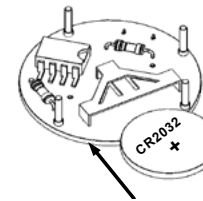

**8 BATTERY**



**9 OPERATION**

-  1 realistically flickering flame - realistisch flakkerende vlam - flamme vacillante - teelicht (Flamme) flimmert realistisch - llama oscilante
-  2 fade in- fade out - ouverture/fermeture en fondu - encendido/apagado lento (fade in/out)
-  3 steady flame - stabiele vlam - flamme stable - teelicht (Flamme) brandt gelijkmatig - llama fija
-  4 deactivated - uitgeschakeld - désactivé - ausgeschaltet - desactivado